

IEA ECBCS Annex 50  
Prefabricated Systems for Low Energy  
Renovation of Residential Buildings

# Retrofit Strategies Design Guide

Advanced Retrofit Strategies &  
10 Steps to a Prefab Module

March 2011

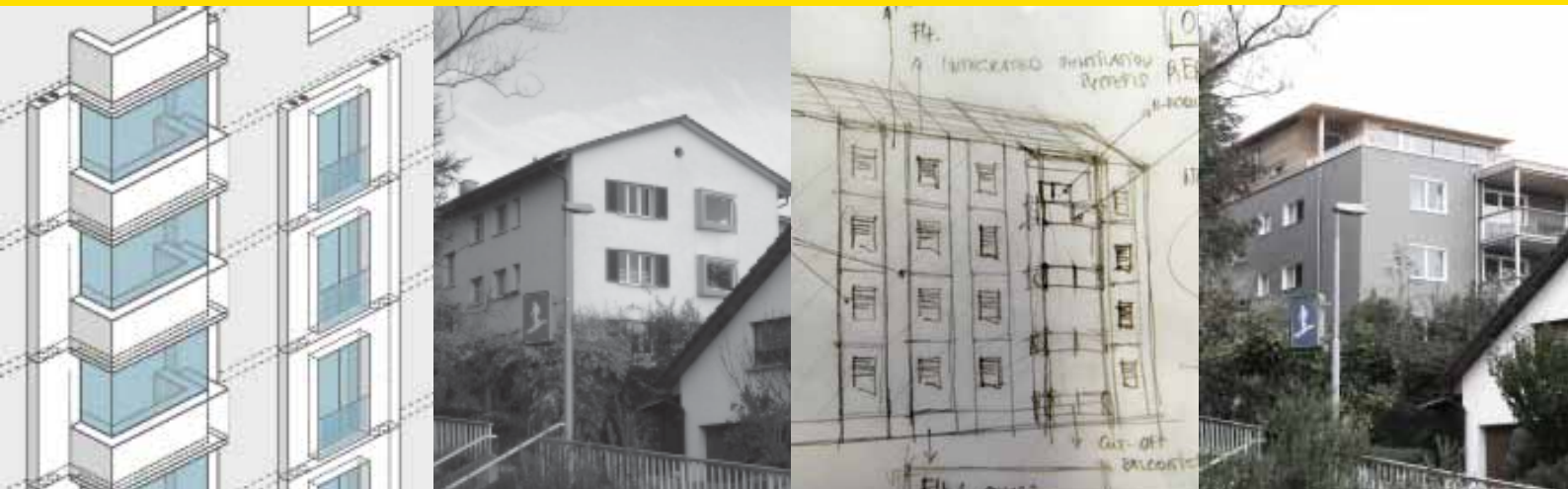

International Energy Agency  
Energy Conservation in  
Buildings and Community  
Systems Programme



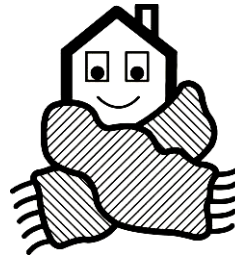

International Energy Agency  
Energy Conservation in  
Buildings and Community  
Systems Programme

IEA ECBCS Annex 50  
Prefabricated Systems for Low Energy Renovation of  
Residential Buildings

# Retrofit Strategies Design Guide

Advanced Retrofit Strategies & 10 Steps to a Prefab Module

March 2011

This report documents results of cooperative work performed under the IEA Programme for Energy Conservation in Buildings and Community Systems, Annex 50 "Prefabricated Systems for Low Energy Renovation of Residential Buildings"

Peter Schwehr, Robert Fischer  
Competence Centre Typology & Planning in Architecture,  
Lucerne University of Applied Sciences and Arts,  
Switzerland

Sonja Geier  
AEE - Institute for Sustainable Technologies (AEE INTEC),  
Austria

Retrofit Strategies Design Guide - Advanced Retrofit Strategies & 10 Steps to a Prefab Module

IEA - International Energy Agency

ECBCS - Energy Conservation in Buildings and Community Systems

Annex 50 – Prefabricated Systems for Low Energy Renovation of Residential Buildings

Operating Agent: Mark Zimmermann, Empa, Switzerland

Funded by the Swiss Federal Office of Energy (SFOE)

Published by:

Empa, Building Science and Technology Lab

CH-8600 Duebendorf

Switzerland

E-mail: [mark.zimmermann@empa.ch](mailto:mark.zimmermann@empa.ch)

<http://www.empa-ren.ch/A50.htm>

<http://www.ecbcs.org>

©Copyright: Copying with reference to "Retrofit Strategies Design Guide IEA ECBCS Annex 50" permitted

Empa - Swiss Federal Laboratories for Materials Science and Technology, March 2011, 100 ex.

ISBN 978-3-905594-59-1

## Preface

### International Energy Agency

The International Energy Agency (IEA) was established in 1974 within the framework of the Organisation for Economic Co-operation and Development (OECD) to implement an international energy programme. A basic aim of the IEA is to foster co-operation among the twenty-eight IEA participating countries and to increase energy security through energy conservation, development of alternative energy sources and energy research, development and demonstration (RD&D).

### Energy Conservation in Buildings and Community Systems

The IEA co-ordinates research and development in a number of areas related to energy. The mission of one of those areas, the ECBCS - Energy Conservation for Building and Community Systems Programme, is to develop and facilitate the integration of technologies and processes for energy efficiency and conservation into healthy, low emission, and sustainable buildings and communities, through innovation and research.

The research and development strategies of the ECBCS Programme are derived from research drivers, national programmes within IEA countries, and the IEA Future Building Forum Think Tank Workshop, held in March 2007. The R&D strategies represent a collective input of the Executive Committee members to exploit technological opportunities to save energy in the buildings sector, and to remove technical obstacles to market penetration of new energy conservation technologies. The R&D strategies apply to residential, commercial, office buildings and community systems, and will impact the building industry in three focus areas of R&D activities:

- Dissemination
- Decision-making
- Building products and systems

### The Executive Committee

Overall control of the programme is maintained by an Executive Committee, which not only monitors existing projects but also identifies new areas where collaborative effort may be beneficial. To date the following projects have been initiated by the executive committee on Energy Conservation in Buildings and Community Systems (completed projects are identified by \*):

Annex 1:	Load Energy Determination of Buildings*
Annex 2:	Ekistics and Advanced Community Energy Systems*
Annex 3:	Energy Conservation in Residential Buildings*
Annex 4:	Glasgow Commercial Building Monitoring*
Annex 5:	Air Infiltration and Ventilation Centre
Annex 6:	Energy Systems and Design of Communities*
Annex 7:	Local Government Energy Planning*
Annex 8:	Inhabitants Behaviour with Regard to Ventilation*
Annex 9:	Minimum Ventilation Rates*
Annex 10:	Building HVAC System Simulation*
Annex 11:	Energy Auditing*
Annex 12:	Windows and Fenestration*
Annex 13:	Energy Management in Hospitals*
Annex 14:	Condensation and Energy*
Annex 15:	Energy Efficiency in Schools*
Annex 16:	BEMS 1- User Interfaces and System Integration*
Annex 17:	BEMS 2- Evaluation and Emulation Techniques*
Annex 18:	Demand Controlled Ventilation Systems*
Annex 19:	Low Slope Roof Systems*
Annex 20:	Air Flow Patterns within Buildings*
Annex 21:	Thermal Modelling*
Annex 22:	Energy Efficient Communities*

- Annex 23: Multi Zone Air Flow Modelling (COMIS)\*
- Annex 24: Heat, Air and Moisture Transfer in Envelopes\*
- Annex 25: Real time HEVAC Simulation\*
- Annex 26: Energy Efficient Ventilation of Large Enclosures\*
- Annex 27: Evaluation and Demonstration of Domestic Ventilation Systems\*
- Annex 28: Low Energy Cooling Systems\*
- Annex 29: Daylight in Buildings\*
- Annex 30: Bringing Simulation to Application\*
- Annex 31: Energy-Related Environmental Impact of Buildings\*
- Annex 32: Integral Building Envelope Performance Assessment\*
- Annex 33: Advanced Local Energy Planning\*
- Annex 34: Computer-Aided Evaluation of HVAC System Performance\*
- Annex 35: Design of Energy Efficient Hybrid Ventilation (HYBVENT)\*
- Annex 36: Retrofitting of Educational Buildings\*
- Annex 37: Low Exergy Systems for Heating and Cooling of Buildings (LowEx)\*
- Annex 38: Solar Sustainable Housing\*
- Annex 39: High Performance Insulation Systems\*
- Annex 40: Building Commissioning to Improve Energy Performance\*
- Annex 41: Whole Building Heat, Air and Moisture Response (MOIST-ENG)\*
- Annex 42: The Simulation of Building-Integrated Fuel Cell and Other Cogeneration Systems (FC+COGEN-SIM)\*
- Annex 43: Testing and Validation of Building Energy Simulation Tools\*
- Annex 44: Integrating Environmentally Responsive Elements in Buildings\*
- Annex 45: Energy Efficient Electric Lighting for Buildings\*
- Annex 46: Holistic Assessment Tool-kit on Energy Efficient Retrofit Measures for Government Buildings (EnERGo)\*
- Annex 47: Cost Effective Commissioning of Existing and Low Energy Buildings\*
- Annex 48: Heat Pumping and Reversible Air Conditioning\*
- Annex 49: Low Exergy Systems for High Performance Buildings and Communities\*
- Annex 50: Prefabricated Systems for Low Energy Renovation of Residential Buildings\*
- Annex 51: Energy Efficient Communities
- Annex 52: Towards Net Zero Energy Solar Buildings
- Annex 53: Total Energy Use in Buildings: Analysis & Evaluation Methods
- Annex 54: Analysis of Micro-Generation & Related Energy Technologies in Buildings
- Annex 55: Reliability of Energy Efficient Building Retrofitting - Probability Assessment of Performance & Cost (RAP-RETRO)
- Annex 56: Energy and Greenhouse Optimised Building Renovation

- Working Group - Energy Efficiency in Educational Buildings\*
- Working Group - Indicators of Energy Efficiency in Cold Climate Buildings\*
- Working Group - Annex 36 Extension: The Energy Concept Adviser\*
- Working Group - Energy Efficient Communities

\* completed

## **Annex 50 “Prefabricated Systems for Low Energy Renovation of Residential Buildings”**

Energy conservation is largely dominated by existing buildings. In most industrialized countries new buildings will only contribute 10% - 20% additional energy consumption by 2050 whereas more than 80% will be influenced by the existing building stock. If building renovation continues at the current rate and with the present common policy, between one to over four centuries will be necessary to improve the building stock to the energy level of current new construction.

Currently, most present building renovations address isolated building components, such as roofs, façades or heating systems. This often results in inefficient and in the end expensive solutions, without an appropriate long term energy reduction. Optimal results can not be achieved by single renovation measures and new problems could arise, including local condensation or overheating.

The objectives of this Annex have been the development and demonstration of an innovative whole building renovation concept for typical apartment buildings. The concept is based on largely standardised façade and roof systems that are suitable for prefabrication. The highly insulated new building envelope includes the integration of a ventilation system.

The concept is focused on typical apartment buildings that represent approximately 40% of the European dwelling stock. The advantages include:

- Achieving energy efficiency and comfort for existing apartment buildings comparable to new advanced low energy buildings i.e. 30-50 kWh/(m<sup>2</sup>·y);
- Optimised constructions and quality and cost efficiency due to prefabrication;
- Opportunity to create attractive new living space in the prefabricated attic space and by in-cooperating existing balconies into the living space;
- A quick renewal process with minimised disturbances for the inhabitants.

The deliverables of the project are:

### **Retrofit Strategies Design Guide**

A building retrofit strategies guide [II] documenting typical solutions for whole building renovations, including prefabricated roofs with integrated HVAC components and for advanced façade renovation. The report is supplemented by the **Retrofit Simulation Report** [IX] and an electronic ‘**Retrofit Advisor**’ [V] that allows a computer-based evaluation of suitable renovation strategies.

### **Retrofit Module Design Guide**

Guidelines for system evaluation, design, construction process and quality assurance for prefabricated renovation modules [III]. This publication includes the technical documentation of all developed renovation solutions.

### **Case Study Building Renovations**

Case studies of six demonstration buildings in Austria, Netherlands, and Switzerland [IV].

### **Technical Summary Report**

A summary report for a broad audience, demonstrating the potential of prefabricated retrofit [I].

Additional publications are:

- Annex 50 Fact Sheet, offering a short overview of the project and its achievements
- Building Typology and Morphology of Swiss and French Multi-Family Homes [VI], [VII], [VIII]

Home Pages: [www.empa-ren.ch/A50.htm](http://www.empa-ren.ch/A50.htm), [www.ecbcs.org/annexes/annex50.htm](http://www.ecbcs.org/annexes/annex50.htm)

**Participating Countries:** Austria, Czech Republic, France, Netherlands, Portugal, Sweden, Switzerland

## Abstract

Buildings have a considerable impact on the implementation of a more sustainable development. Within this context "IEA ECBCS Annex 50 – Prefabricated Systems for Low Energy Renovation of Residential Buildings", focuses on the most important sector of multi-residential buildings. It aims at contributing to quality control and standardization based on prefabricated modules and advanced retrofit strategies. The project focuses on prefabricated and factory-assembled roofs, façades, and HVAC systems for multi-family houses.

However, it is not just a question of resolving technical issues. Today, holistic strategies have to meet the needs of investors, users and the public, as well as to account for architectural relevance. Planners are required to develop optimal retrofit strategies for existing buildings. Advanced retrofit strategies involve the whole building system and aim to get buildings "fit" and to adapt them for current and future needs. The core element of every redevelopment should be an increase in value for the client (investor, building owner, and tenant). Focusing solely on the optimization of energy efficiency is ineffective, and does not meet overall requirements. This report gives guidelines for the strategic planning of this type of residential building renovation. Based on the premise mentioned above, we use the term *advanced retrofit*.

Based on an initial assessment of the building's potential (market potential and preliminary building analysis), planning is approached using a checklist (evaluation sub-divided according to the needs of stakeholders). The building typology allows to scan residential buildings and estates especially in view of their potential (building analysis, location analysis). The aim of the strategic planning is to effect retrofit strategies with the highest possible added value i.e. ones which have the greatest possible benefit for everyone involved (target agreement), and as a result, to achieve a high multiplication potential. The subsequent phases of advanced retrofit are planning, realization, and target efficiency evaluation.

The focus of this report is the building renovation with industrialized, prefabricated modules and its influence on strategic planning of an advanced retrofit. In **Part A** the 7 steps of an advanced retrofit strategy are presented. In **Part B** a 10 step guideline for the implementation of multifunctional renovation modules is provided for builders, planners and manufacturers in order to support their decision-making process during the planning and production. The design and construction of the retrofit module-systems within Annex 50 is part of the "Retrofit Module Design"[II].

### Concept of Prefabricated Systems

For the development of prefabricated retrofit systems, the following three fundamental aspects were considered:

- The modules are **standardised in construction**, layers, and joints
- The modules are **flexible in architecture**, form, and cladding
- The modules **can be combined** with each other and with non-prefabricated (conventional) retrofit options

Façade and roof modules with a large application potential were designed based on a building typology. So far, the prefabrication technology for façade and roof modules has been developed and tested. Special attention was given not only to building physics, but also to fire protection and logistics. There are two different approaches for retrofit module design: One is a fully prefabricated solution, the other concentrates on prefabrication at the window area as being the area with the highest density of details. Modules for roofs and balconies are developed in the same way.



Completely prefabricated



Semi prefabricated with F4.1 modules (see [II])



Figure 1: Two design and construction approaches for modular retrofit systems

Fundamentally, the module consists of:

- 1) An equalizing layer mounted on the existing outer wall,
- 2) A load bearing construction with insulation layer and integrated ducts,
- 3) A second layer of insulation material. The thickness of the insulation can be chosen depending on the desired U-value and
- 4) A cladding layer that can be prefabricated and delivered with the module, or mounted on site.

**Construction principle**

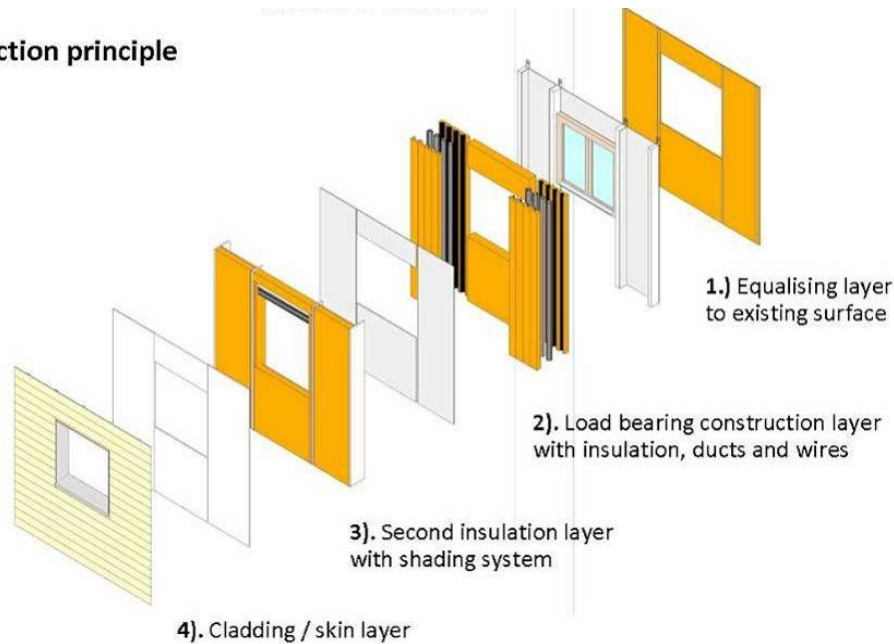

Figure 2: Assembly of the Swiss module (© René Kobler, FHNW)

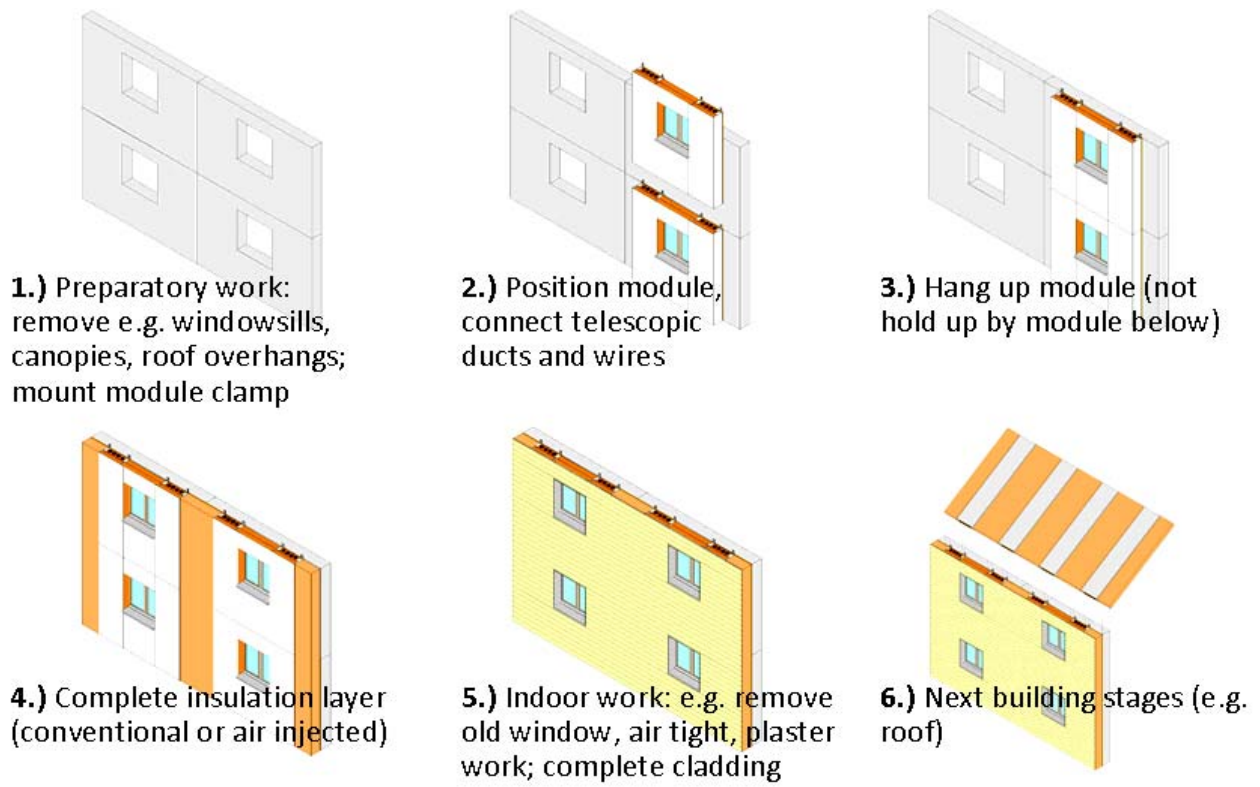

Figure 3: Example of semi prefabricated façade modules combined with conventional retrofit options [11]

## Table of Content - Overview Part A and B

<b>Part A: Advanced Retrofit Strategies</b>	<b>11</b>
1. Introduction	14
2. Initial questions	16
3. Preliminary evaluation of building renovation strategy	16
4. Stakeholder checklist	20
5. Building typology	24
6. Added value checklist	26
7. Planning and realization phases	39
8. Evaluation of target effectiveness	46
9. References	46
<b>Part B: 10 Steps to a Prefab Module</b>	<b>49</b>
<b>Introduction</b>	<b>53</b>
1. Initial situation	55
2. Existing building stock	60
3. New building envelope	65
4. Fire prevention	71
5. Sound insulation	77
6. Building physics and ecology	82
7. Basic module kit	87
8. Joint and fixing techniques	92
9. Service module kit	97
10. Active module kit	100
11. References	104



# Part A

## Design Guide Advanced Retrofit Strategies

Authors:

Prof. Dr. Peter Schwehr, Robert Fischer  
University of Applied Sciences and Arts - Engineering and Architecture (HSLU)  
Competence Centre for Typology and Foresight Planning in Architecture (CCTP)

Lucerne, March 2011

The participation in IEA ECBCS Annex 50 was funded by the  
Swiss Federal Office of Energy SFOE  
and  
Swiss Innovation Agency CTI  
3003 Berne



## Table of content - Part A: Advanced Retrofit Strategies

<b>Part A: Advanced Retrofit Strategies</b>	<b>11</b>
<b>Introduction</b>	<b>14</b>
<b>1. Initial questions</b>	<b>16</b>
<b>2. Preliminary evaluation of building renovation strategy</b>	<b>16</b>
2.1. Building strategies.....	17
2.2. Methods for preliminary evaluation of building strategy.....	17
2.2.1. <i>Building analysis</i> .....	17
2.2.2. <i>Market potential evaluation</i> .....	18
2.2.3. <i>Comparison of market potential and building substance</i> .....	19
2.3. Conclusion of preliminary evaluation.....	19
<b>3. Stakeholder checklist</b>	<b>20</b>
3.1. Public authorities.....	20
3.2. Building operators.....	20
3.2.1. <i>Legal Framework</i> .....	20
3.2.2. <i>External factors</i> .....	21
3.2.3. <i>Use scenario</i> .....	21
3.2.4. <i>Financing scenario</i> .....	22
3.3. Users (from the building operators' point of view).....	23
3.3.1. <i>Surroundings</i> .....	23
3.3.2. <i>Building</i> .....	23
3.3.3. <i>Floor space / apartment use</i> .....	24
3.3.4. <i>Construction</i> .....	24
<b>4. Building typology</b>	<b>24</b>
<b>5. Added value checklist</b>	<b>26</b>
5.1. Features of surroundings.....	28
5.1.1. <i>Location within community and size of community</i> .....	28
5.1.2. <i>Number of same or similar type of buildings</i> .....	28
5.1.3. <i>Quality of neighbourhood</i> .....	29
5.1.4. <i>Open spaces</i> .....	29
5.2. Building features.....	31
5.2.1. <i>Time of construction</i> .....	31
5.2.2. <i>Renovation strategies</i> .....	31
5.2.3. <i>Number of apartments</i> .....	32
5.3. Features of main access.....	34
5.4. Features of the storeys.....	36
5.4.1. <i>Height of storeys</i> .....	36
5.4.2. <i>Storey categories</i> .....	36
5.5. Features of the apartments.....	38
5.5.1. <i>Type of kitchen</i> .....	38
5.5.2. <i>Living space</i> .....	38
5.5.3. <i>Balconies</i> .....	38
<b>6. Planning and realization phases</b>	<b>39</b>
6.1. Challenges.....	39
6.2. Prefabricated retrofit systems.....	39
6.3. Flexible in architecture.....	39
6.4. Variation of application and cladding materials.....	40
6.4.1. <i>Integration of solar collectors</i> .....	41
6.5. Pilot case study Weinberglistrasse 62, Lucerne, Switzerland.....	41
<b>7. Evaluation of target effectiveness</b>	<b>46</b>
<b>References</b>	<b>46</b>

## Introduction

The greatest challenge in the renovation market is to find new solutions for an existing situation (built structure and its use). Existing buildings are living quarters that have their use, inhabitants, identity, and atmosphere. At the same time, existing buildings have a given structure that planners have to take into consideration. "This is a different market to the one where you can design a beautiful structure on a green field site"<sup>1</sup> Increase in value is achieved by a combination of usability, technological quality and the atmosphere created.

A building strategy determines which investments should be made for a certain period of the building's service life. Today, a long-term building strategy is often lacking. Retrofit measures are often only tackled when they are unavoidable (e.g., when the roof leaks or the heating must be replaced). This often leads to uncoordinated, partial renovations that eventually result in additional costs<sup>2</sup>.

An advanced retrofit strategy aims at establishing a holistic building strategy for the entire, remaining life cycle of the building. The ultimate option in the building strategy is to construct a new building in replacement.<sup>3</sup> An advanced retrofit strategy determines whether a building reaches this condition in five, twenty-five, one hundred, or more years. Intermediate objectives of an advanced retrofit strategy can be building maintenance, partial renovation, or comprehensive renovation (see 2.1 Four Building Strategies)

In an advanced retrofit strategy, the technical retrofit options are compared with the realizable added value and incorporated into a holistic strategy. Typology provides the information needed. The following seven steps are characteristic for an advanced retrofit:

- I. Market potential evaluation and preliminary building analysis**  
Preliminary estimate of potential to determine subsequent planning of value retention, part-renovation, comprehensive renovation or a new building replacement  
(Instrument: Preliminary evaluation of building strategy)
- II. Needs evaluation**  
Identifying the needs and parameters of the most important stakeholders and multipliers of advanced retrofit: Owners, planners, constructors and public authorities  
(Instrument: Chapter 2: Stakeholder checklist)
- III. Building analysis**  
Detailed analysis of the built structure and its relevant system components. Identifying retrofit options (Instrument: Chapter 3: Building Typology)
- IV. Target agreement**  
Combining retrofit options to provide a building strategy with high added value over the entire life cycle. Determining possible phases  
(Instrument: Chapter 5: Added value checklist)
- V. Planning Phase**
- VI. Realization Phase**  
Planning and realization of an implementation stage  
(Instruments: 10 Steps to a Prefab Module<sup>4</sup> and Retrofit Module Design Guide [II])
- VII. Target Effectiveness Evaluation**  
Evaluation of reaching objectives during at least one year of operation after work completion. Possible adaption of the building strategy in stages (after target agreement) or re-evaluation of building strategy (before target agreement).

<sup>1</sup> See interview with Martin Meier, renovation expert [11]

<sup>2</sup> See [4]

<sup>3</sup> Exceptions are buildings listed as objects of special architecture or historic interest. For these buildings, replacement is not an option. The aim is to maintain the building substance (theoretically forever).

<sup>4</sup> Part B of this report



At the very beginning of an advanced retrofit, initial questions help to make the right decisions for further planning. Steps I, II, III, and IV (market potential evaluation, needs evaluation, building analysis, and target agreement) combine to give the strategic planning of an advanced retrofit strategy.

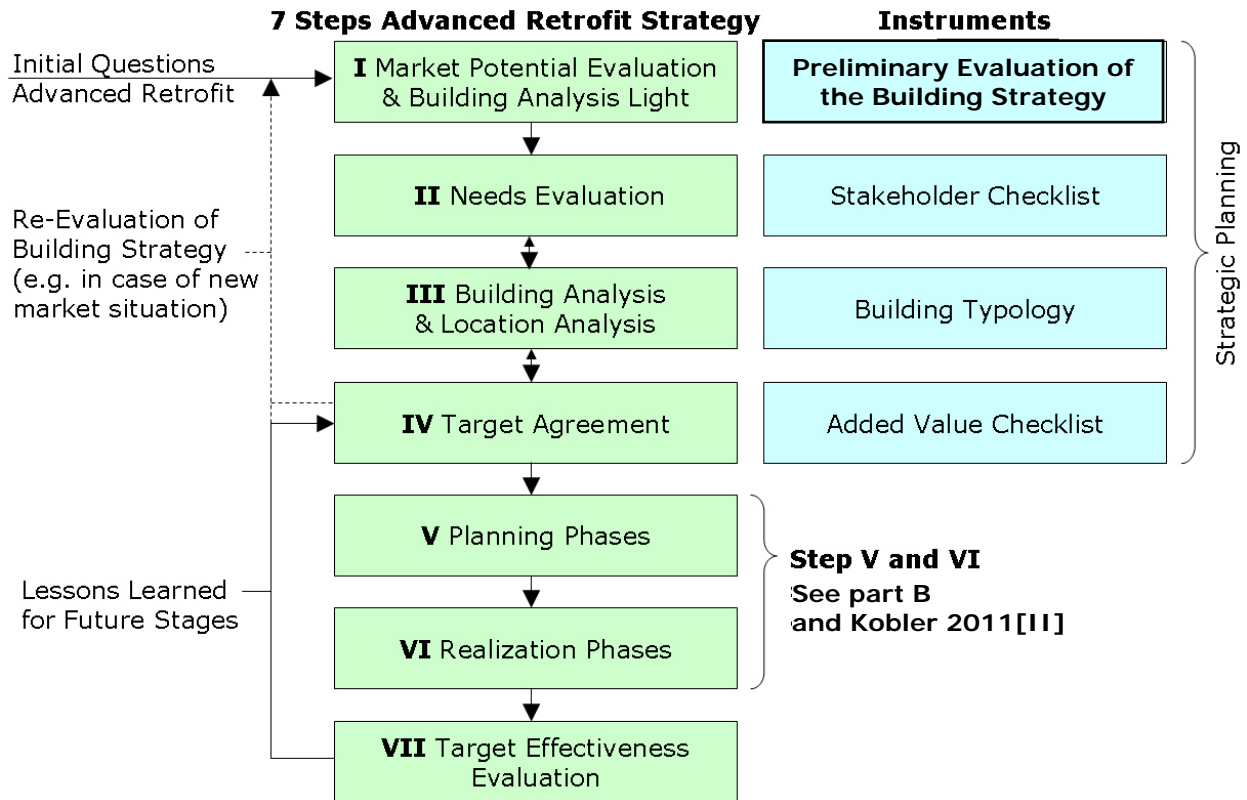

Figure 4: The seven strategy steps for advanced retrofit

## 1. Initial questions

The following questions are the starting point of an advanced retrofit strategy:



***How long can and should the residential complex continue to operate in its current form?***

How much costs the ongoing and periodical maintenance? When does the strategic planning of advanced retrofit (step I-IV) have to be completed, and when must project planning (step V) begin<sup>5</sup>?



***Do all partners have the building-, economic- and tenant-specific data?***

Which data are necessary to balance advantages against disadvantages of partial renovation, comprehensive renovation, or new building replacement? If necessary data are not available: Can they be detected elsewhere (e.g. communal/municipal archives for existing buildings) or does a survey have to be carried out (e.g. building measurement, tenant satisfaction, user suggestions for improvement)?



***Which parameters are set by owners (of private nature) or authorities (of legal nature)?***

How do they influence the decision-making? How are these communicated to the other partners of the advanced retrofit?

## 2. Preliminary evaluation of building renovation strategy

Determining an appropriate and sustainable building strategy and the procedure for realizing it, presents a challenge for all parties involved. The chances and risks of the different levels of intervention from maintenance or value retention to partial renovation, and from comprehensive renovation to replacement are multi-faceted. Creative solutions are often amazingly affordable. Depending on the market situation, a combination of different levels of intervention (e.g. comprehensive renovation of the building envelope, replacement of building technology and maintenance work in the apartments) can present new opportunities.

The checklist in the next chapter 3 “Stakeholder checklist” aids decision-making and promotes understanding between the parties involved (building operators<sup>6</sup>, planners, contractors and public authorities). However, before the advantages and disadvantages of an advanced retrofit building strategy can be evaluated, a suitable project team has to be appointed by the building operators. The following preliminary estimate of the building strategy assists in awarding contracts wisely.

<sup>5</sup> Depending of size and complexity of the project, it takes a further period of 8-24 months until the building work is completed, objections not accounted for!

<sup>6</sup> The term building operators include:  
 - Property owner  
 - Property management  
 - Property administration

## 2.1. Building strategies



### **Value Retention:**

First measures are necessary after 10 to 15 years of use: Renewing carpets, wall coverings etc.

*(Minimal project team required: Building operators and those contractors realizing the project)*



### **Partial renovation:**

After 20 to 25 years, a partial renovation is inevitable: Interior work, bathroom, toilet, kitchen, parts of the building envelope, building technology etc.

*(Minimal project team required: Building operators, planners, contractors and public authorities)*



### **Comprehensive renovation:**

A comprehensive renovation is usually necessary after 40 to 50 years: New building envelope and building technology, installations, and total interior renovation. The value based on the condition of the building after a comprehensive renovation may be lower or higher than the value of a new building, depending on the extent of the measures taken.

*(Minimal project team required: Building operators, planners, contractors and public authorities)*

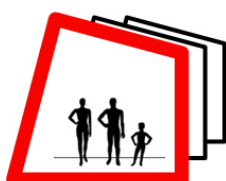

### **New build replacement:**

Investing in the existing building is not worthwhile because of the building structure and its market potential. There is however, the potential of improved use of the plot.

*(Minimal project team required: Building operators, planners and public authorities)*

## 2.2. Methods for preliminary evaluation of building strategy

The appropriate building strategy can be identified with a simplified evaluation of the building substance and the market [5]. However, the owner's subjective view makes evaluation more difficult. This phase already involves difficult structural assessments (e.g. earthquake safety evaluation), and it is therefore advisable to engage an expert (e.g. an architect with expertise in building renovation).

### 2.2.1. Building analysis

During the building analysis, particular attention is to be paid to assessing the quality and state of the existing structure and its adaptability.

Question	YES	NO
Energy use: Is the energy use already low enough to lessen the risk of the premises to become vacant when energy costs rise? (An initial assessment is possible using the Swiss GEAK tool - Gebäudeenergieausweis der Kantone - Cantonal Energy Certificate for Buildings) <sup>7</sup>		
Structural condition: Are the roof, façades and windows still in good condition? Has the life cycle of the building technology (heating, hot water) been reached? Is earthquake safety guaranteed or simply to be improved? In areas of increased risk of earthquakes, it is worth carrying out a professional seismic performance analysis at this stage of an advanced retrofit strategy.		
Condition of fixtures and fittings: How are the bathroom, toilets, and kitchen equipped? Do these rooms meet today's requirements? Do the apartments comply with today's standards (e.g. room height, lighting conditions, and sound insulation)?		
Room allocation and floor space: Does the room allocation and floor space cover today's requirements? Is a simple adaptation of the room allocation possible?		
<b>Overall evaluation: Is the building structure good?</b>		

Table 1: Simplified evaluation of the building substance

### 2.2.2. Market potential evaluation

When considering market potential, particular attention should be paid to future developments in demand for living and commercial within the neighbourhood. How can the available space (size of apartment, number of rooms, utility rooms, and infrastructure) be adapted to meet today's needs and future market requirements? The two following strategies may be used to minimize risk:

#### Flexibilization

Targeting the mainstream requirements on the rental market. Transforming the available space into units with maximum user neutrality that can be rented by different user groups with different needs.

#### Diversification

Targeting particular user groups (e.g. senior, apartment-share, musicians, etc.). The diversification strategy can open up interesting possibilities - especially for difficult objects that no longer meet mainstream requirements on the rental market.

Question	YES	NO
Environment: Does the position and location of the object lead to expect above-average performance (community, noise, view, infrastructure, public transport, neighbourhood, and building identity)? Is the diversification strategy applicable?		
Tenants: Long-term, satisfied tenants secure return on investment. Are the tenants willing to pay more for improved conditions? Is the diversification strategy applicable?		
Use potential: Is it possible to use the building and premises more intensely and as a result, to increase profits? Do building regulations allow for extension?		
<b>Overall evaluation: Is the market potential good?</b>		

Table 2: Simplified evaluation of the market potential

<sup>7</sup> The GEAK Tool is available in German, French and Italian under <http://www.geak.ch/>

### 2.2.3. Comparison of market potential and building substance

The following diagram from the evaluation of market potential and building substance identifies a suitable building strategy. Evaluation of market potential and building substance may be different, in the case of another user group (e.g. students).



	Poor building substance	Good building substance
Poor market potential	 <p><b>Value retention:</b> The aim is to secure the future use of the building without jeopardizing habitability and rental revenue</p>	 <p><b>Partial renovation:</b> The aim is to secure earnings and value of the building in the long-term, or increase them accordingly.</p>
Good market potential	 <p><b>New build replacement:</b> Investing in the existing building is not worthwhile because of the building structure and its market potential. There is however, the potential of improved use of the plot.</p>	 <p><b>Comprehensive renovation:</b> Building substance and market potential allow for comprehensive investments that lead to a clear appreciation of the building.</p>
Conclusion	<p>If the preliminary estimate shows that <b>value retention</b> can be achieved, or that a <b>new build replacement</b> makes sense, they can easily be developed with the planners and contractors.</p>	<p>If the preliminary estimate shows that a <b>partial or a comprehensive renovation</b> makes sense, these have to be looked at in depth. Often a combination of different strategies is chosen - in this case, it is also worth weighing up the chances and risks in more closely. The checklists in the following chapters may be used for this.</p>

Table 3: Preliminary evaluation of building strategy based on building substance and market potential

### 2.3. Conclusion of preliminary evaluation

If the preliminary evaluation shows that a partial or a comprehensive renovation makes sense, they have to be looked at in depth. Often a combination of different strategies is chosen. It is also worth weighing up the chances and risks closely. The checklists in the following chapters may be used for this.

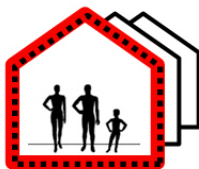
### 3. Stakeholder checklist

Successful renovation projects combine the different perspectives of all parties to reach a mutually supported building strategy which can also be realized in stages if needed. The checklists will assist property developers in reaching a well-founded decision that will be supported by all parties.

Questions in the following checklist are raised from the perspective of authorities, owners, users, planners, and contractors. They indicate the chances of added values for the advanced retrofit of residential buildings and complexes. In planning building retrofit, the priority of the questions changes, depending on the perspective.

#### 3.1. Public authorities

Public interest and private investment in housing are closely linked. Building investments are subject to building inspectorate and spatial planning laws that are laid down in municipal laws and regulations. Subsidies (e.g. for energy) and benefit schemes (e.g. for re-densification) are set as incentives for realizing projects of public interest. Renovation is always an opportunity for added value concerning both private and public interests.

The following questions have to be answered from the authorities' perspective:

Question	YES	NO
Is there a need for subsidized housing?		
Is there a need for a certain type of housing for particular user groups (e.g. seniors, students, families)?		
Can specific user groups sustainably influence the development of the neighbourhood?		
Does the building make a valuable contribution to the town? (architectural preservation and protection)?		
Is the building of historic interest, worthy of protection (object protection)?		
Are planning instruments available to improve urban and architectural quality? (e.g. architectural competition/study assignment)?		
Are planning instruments available to change valid land use regulations (e.g. an increase in the floor space index for a design plan)?		
Are there any building inspectorates or planning regulations that might possibly be bypassed (e.g. old building lines, design regulations, parking spaces)?		
Is the land register for this zone up to date (e.g. contaminated sites, noise pollution, district heating systems etc.)? Is it available to building owners and planners?		
<b>Do the building operators and planners know about the points that have been answered YES?</b>		

Table 4: Checklist for representatives of the authorities

#### 3.2. Building operators<sup>8</sup>

The building operators' perspective includes questions related to the property owner, property management, and property administration

##### 3.2.1. Legal Framework

Questions raised in this section concern the legislative and regulatory framework. It is important to be able to answer all questions with a YES or a NO. It may be necessary to clarify with the relevant authorities.

<sup>8</sup> Suggestions from the following sources were taken into consideration [10], [12]

Question	YES	NO
Are there any land reserves? What is the potential of densification? Can another storey be added or is it possible to convert the attic?		
Are there specific zoning regulations that must be considered for renovation, extension, or new build replacement? (e.g. will an increased floor space index be granted?)		
Is the object listed as a building of historic interest (object protection)?		
Are there any servitudes that have to be considered in view of a renovation?		
Is the property exposed to emissions that are above the legal limit (e.g. noise pollution)?		
<b>Have all questions been answered with yes or no?</b>		

Table 5: Checklist for building operators in view of legal regulations

### 3.2.2. External factors

In this part, external factors are investigated for long-term positioning of the object on the rental market. The questions should be answered as comprehensively as possible in order to be able to consider them when formulating planning objectives.

Question	Planning objective
Are other changes foreseeable in environmental influences and emissions (e.g. aircraft noise, noise barriers on motorways, bypasses)? If yes, what effects are they expected to have on the building?	
What will future accessibility with public transport look like? Is the neighbourhood connected to major transport routes?	
Are goods and services provided to cater for daily, weekly, and long-term needs?	
What is the micro-location of the building like (e.g. noise emissions, view, and other emissions)?	
Is the property located in a specific hazard zone (e.g. flooding)?	
<b>Have the external factors for this object been clarified?</b>	

Table 6: Checklist for building operators in view of external factors

### 3.2.3. Use scenario

In this section, questions concern targeting the object to a certain user group or a certain mix of use. The questions are answered according to a user scenario. Based on this scenario, planning objectives are formulated with the planning team in the target agreement. It is also possible to develop different use scenarios and check their feasibility in the initial planning stage. As a rule, use scenarios are developed based on the existing use mix. A new use must be carefully planned, initiated and realized.

Question	Planning objective
What do the tenants especially appreciate? What can be improved and which requirements are currently not catered for?	
On average, how long do tenants stay in the apartments? Are there problems in letting the property (vacancies that are not due to relocation or renovation)?	
What is the current tenant mix (age structure, types of household, origin, number of people in each apartment, income levels)?	

What is the relationship between the tenants? Are there any complaints? If yes, what? (noise, social conflicts, safety, vandalism, etc.) Are there any problems because of the mix of tenants?	
What is the tenants' relationship to the neighbourhood? Are there any complaints? If yes, what (noise, social conflicts, safety, vandalism, etc.)?	
Have maintenance costs increased? If yes, why (moisture damage and mould due to inadequate airing, repairs due to faulty manipulation or vandalism)?	
Which problems and needs can be addressed with measures taken by property management? Are structural measures necessary?	
What is the future demand for apartments in this area estimated to be? How will the neighbourhood develop in future (percentage of seniors, foreigners, families with children)? Will the percentage of housing in the area tend to increase or decrease?	
Which type(s) of tenants does the property developer want to attract and in which rental price bracket?	
Is a mix of use being targeted for this building? Which?	
How should the apartments be upgraded to meet the needs of future tenants? Can special provisions be made to encourage social contact and a range of services (meeting places, common rooms, playgrounds, etc.)?	
What will happen to the existing tenants in case of renovation? Is termination of tenancy possible, or should it be avoided? What are the possible alternatives for persons affected?	
<b>Has a use scenario been defined for the building by answering these questions?</b>	

Table 7: Checklist for building operators related to the use scenario

### 3.2.4. Financing scenario

In this part, questions are raised concerning the current value of the building and financing possibilities of an advanced retrofit strategy. Questions are answered in a financing scenario. Based on this scenario, planning objectives are stipulated with the planning team in the target agreement. It is also possible to develop different financing scenarios and to check how realistic these assumptions are during the initial planning stage.

Question	Planning objective
How high is the current residual value (book value) of the property offset against the number of future apartments?	
What is the condition of the building? Do the building and its components comply with today's standards and the expectations of the targeted user group?	
Which elements fulfil their function inadequately because they are dated and need to be replaced? Are these inevitable repair costs quantifiable?	
Which financial means are available for renovation? What percentage should or can be outside financing?	
What is the scope for rent increase after renovation? Should a percentage of subsidized apartments be provided?	
How much return on equity should or can be achieved with the object (income property approx. 5%, capital investment 3-4%, property for 'aficionados' <2%)?	
<b>What importance does the building have from a monetary point of view?</b>	

Table 8: Checklist for building operators related to financing



### 3.3. Users (from the building operators’ point of view)

Apartment design, fittings and furnishings, conditions of use and last but not least, the rent, influence an apartment's suitability for certain groups of tenants. The apartment's suitability for certain user groups is investigated based on its surroundings. The amount of effort in optimizing the object for this user group is checked continuously during the process. The following checklist serves to best align the rental property to the targeted user group, and help estimate the effort required.<sup>9</sup>

#### 3.3.1. Surroundings

Question	Planning objective
For which user group is the object's location suitable or predestined (social environment; tax rate; distance to: public transport, shopping facilities, schools, colleges, recreational areas and facilities offered: childcare, leisure and sport, culture, home care, healthcare, restaurants)	
Are there aspects in the neighbourhood that could influence a user group's decision? (What reputation does the neighbourhood have? Can you get home safely after dark? Are there particular sources of noise such as restaurants, school playgrounds, and church bells? Are there any odour nuisances?) etc.	
Which user group fits into the existing neighbourhood? Which user group could sustainably influence the development of the neighbourhood?	
Which common use of outdoor features is especially important for the user group? (patio, barbecue, playground, playing field, play street). Do these already exist or can they be set up with a reasonable amount of effort?	
Does the entrance to the house suit the needs of the user group (barrier-free access)?	
<b>For which user group are the surroundings particularly suited?</b>	

Table 9: Checklist for use of building surroundings

#### 3.3.2. Building

Question	Planning objective
Does the user group harmonize with the other occupants in the multi-family building (child-friendly, landlord living on the premises)?	
Which additional rooms are especially important to the user group (storage space in the attic or cellar, stone cellar, hobby room, parking space, bicycle parking, place for prams and sports equipment, drying rooms, etc.)?	
What is the maintenance fee limit that a typical household in the user group can pay? How sensitively does the user group react to increasing maintenance fees (e.g. as a result of increased energy costs)?	
Which aspects of the house are particularly important to the user groups (Is it permitted to play a musical instrument in the house? Are animals permitted? Is there a caretaker? How often can the laundry room be used?)?	
<b>For which user group is the building particularly suited?</b>	

Table 10: Checklist for use of building

<sup>9</sup> Suggestions from the following sources were taken into consideration [2], [8]

**3.3.3. Floor space / apartment use**

Question	Planning objective
Which layout appeals to the user group (number of rooms, size of rooms, connections between the rooms, open or closed kitchen, number of bathrooms and toilets)?	
Which private outdoor areas do the user group want (balcony, loggia, patio, terrace, vegetable garden)?	
What kind of atmosphere especially appeals to the targeted user group (state of the apartment, lighting conditions, etc.)?	
Which standard suits the targeted user group (floor coverings, walls, ceilings, built-in appliances, kitchen and bathroom fittings, built-in cupboards)?	
How much rent can or does a typical household in the user group want to pay?	
<b>For which user group is the apartment particularly suited?</b>	

Table 11: Checklist for use of apartment

**3.3.4. Construction**

How sensitively do the user groups react to the physical building characteristics? (e.g. sound-absorption in the building, soundproofing of exterior noise, draughts and cold air drop, surface temperature of floors and walls, dampness) Do the users think that renovation is necessary for the building elements concerned (e.g. outer shell, party walls, ceilings, building technology)? Targeting a certain standard or an advanced standard for classical comfort parameters (according to Fanger)?

**4. Building typology**

A building typology provides basic data for the evaluation of the renovation potential of the existing building stock, and for the definition of retrofit strategies and the envelope characteristics of specific building types. The typology is not limited to building shape, but also considers besides the building structure, the needs of owners and tenants, and procedures such as retrofit design, building use and maintenance. The study identifies the major characteristics of various building parts (balconies, windows or other details of building envelope and structure) for a statistically relevant number of buildings. The types inside the typology are comparable because they are based on the same parameters. For market studies, the typology is directly linked to the data collection of the Swiss Federal Statistical Office (SFSO). Finally, the typology is fundamental for the development of prefabricated modules and essential for estimating the market potential of the newly developed enclosure systems for retrofit.

For further information see: *Building Typology and Morphology [VI]*

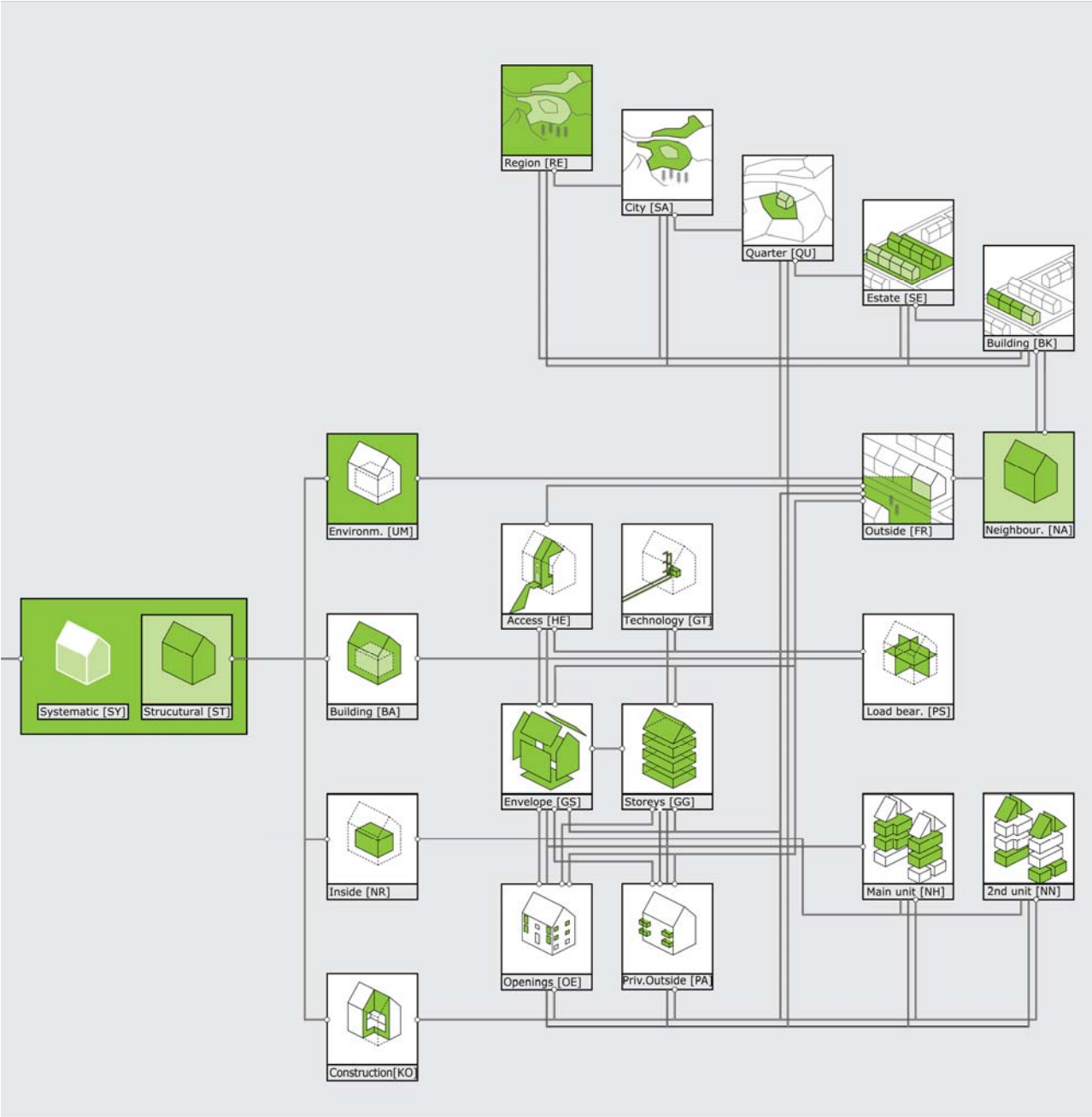

Figure 5: Classification of the relevant features with focus areas for the typology of multi-family homes

## 5. Added value checklist

This chapter includes the most important planning guidelines for achieving added value in the renovation of residential buildings with prefabricated elements. It is principally directed toward the building operators. Their initiative is needed to secure sustainable value retention of the property. The typo-logical profile of an individual building serves as the basis for the checklist.

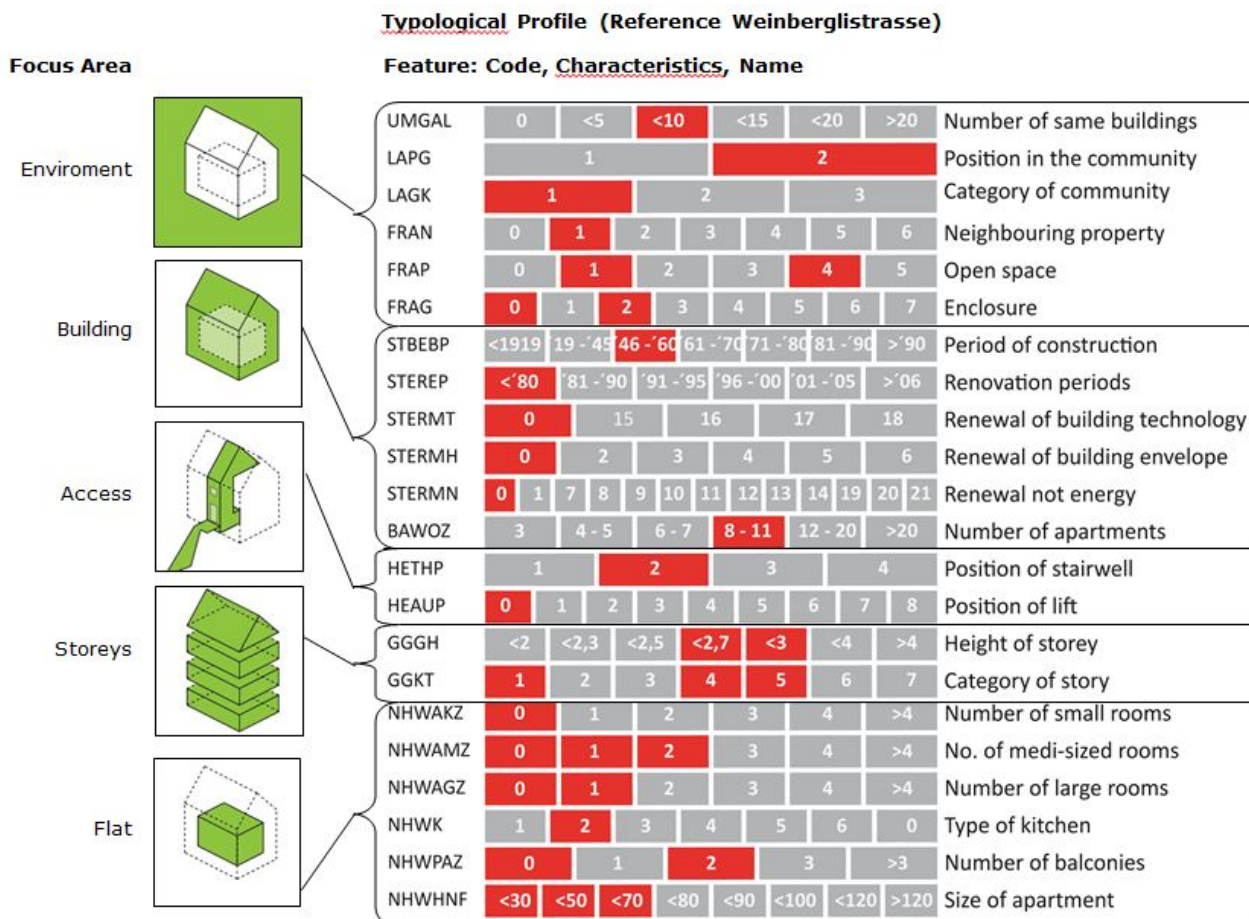

Figure 6: Typological profile. The main elements are: the focus area (left), relevant features (right). Example of a completed typological profile for apartment building “Weinberglistrasse 62, Lucerne (red = applicable, grey = not applicable)



Northeast façade of case study building, Lucerne (see chapter 6.5), photo by R. Fischer, HSLU-CCTP

## 5.1. Features of surroundings

### 5.1.1. Location within community and size of community

The location within the community and the size of the community are key factors for most user groups when looking for an apartment. For the owners, this is an indicator for targeting certain user groups. For example, it does not make much sense to offer family apartments in the city centre, except under special circumstances. Families wishing to live directly in the city centre (and who can afford it), are clearly a minority [4].

The diversification or flexibilization of rented property (see 2.2.2.) aims to reduce the risk of not being able to rent the property. Knowing the individual housing market (e.g. demand for student accommodation) for a particular location is imperative for making decisions.

For all user groups, transport accessibility is a key issue. In a renovation strategy, it is therefore worth considering the mobility profile of potential tenants and the advantages and disadvantages of the location.

Situation	Planning questions
Central location in a medium or large-sized city with a well-developed public transport system. The occupants do not usually travel by car.	Can the number of parking spaces be reduced in view of good public transport connections and with the consent of the building authorities?  Can unused parking space be reallocated as an atelier, offices, playgrounds, or patios?
Location close to city suburbs with access to public transport. The occupants do not usually travel by car.	With the consent of the building authorities, can the number of parking spaces be reduced in view of good public transport connections?  In the case of poor public transport connections, is there an adequate number of car and scooter parking spaces?
Located in the centre of a village. Cars are the preferred means of transport. Good access to public transport is becoming more important.	Can the walk to the next public transport stop be shortened?  In the case of poor public transport connections, is there an adequate number of car and scooter parking spaces?
Located in the countryside but not in a village. Cars are the main means of transport.	Is there an adequate number of car and scooter parking spaces?

### 5.1.2. Number of same or similar type of buildings

Explanation	Measure
For neighbouring buildings of the same type, costs can be saved in planning and realization because of the effect of quantity.	Is it possible to team up with neighbouring owners of the same type of building for renovation-planning?  Can a district heating system be established with neighbouring house owners?

**5.1.3. Quality of neighbourhood**

Explanation	Planning questions
The location of the building has an influence on both rent and rentability.	<p>Are the owners and neighbours involved in the development of the neighbourhood? What visions do they have and is there a common factor?</p> <p>Are there are any new insights in energy, architecture and housing research which could be useful for the development of the neighbourhood?</p>

**5.1.4. Open spaces**

Situation	Planning questions
Green spaces that have not been allocated to a specific use <sup>10</sup> .	<p>Can patios or vegetable gardens be laid out?</p> <p>Would an extension upgrade the building?</p> <p>Are there any children's play areas? Could new ones be created in agreement with the owners of the neighbouring property?</p>
Enclosures <sup>11</sup> between one's own and the neighbour's property.	Can the enclosure be replaced with any other structure (e.g. playground, trees)?
The open space borders onto a public footpath or side street with little traffic.	<p>Are changes to be expected regarding traffic emissions from the side street, and is it possible to include these in the renovation strategy?</p> <p>Do the noise barriers and screening have to be altered because of these changes?</p>
Open spaces and parking spaces that border a side street with moderate traffic.	<p>Is there sufficient, easily accessible bicycle parking?</p> <p>Can narrow bike rooms be used for another purpose?</p> <p>Can hard-surfaced areas be upgraded by using this space for an extension?</p> <p>Can an underground car park be built to reallocated parking spaces in favour of a new outdoor structure?</p>
Sides of a building that border directly onto a main road or side street.	Can ground floor apartments or garages be converted into offices, ateliers, shops, or childminding facilities? Is there demand for these amenities in the neighbourhood? Could such a demand be stimulated?

<sup>10</sup> Include unused, grassed areas (keep off the grass! no ball games!) and areas covered with ground cover plants.

<sup>11</sup> Enclosures include all dense, impenetrable hedges, fences and walls



Northwest façade of case study building, Lucerne (see chapter 6.5), photo by R. Fischer, HSLU-CCTP



## 5.2. Building features

### 5.2.1. Time of construction

Given the time of construction, experts are able to draw conclusions about the methods of construction. However, buildings from the same period can be constructed differently depending on the innovation of the architects and craftsmen involved. As a rule, new techniques were applied in the cities at an early stage whereas the major part of the buildings in the countryside was built following traditional, proven methods<sup>12</sup>.

Explanation	Planning questions
The age of the building is an important clue to the possible type of construction and the standards to which it was built.	Has all possible information about the building been gathered? Each piece of information is valuable to the planning experts and allows conclusions to be drawn about the building's authenticity <sup>13</sup> and its construction.

### 5.2.2. Renovation strategies

Situation	Planning questions
The building technology has never been renewed. In the long term, rising prices for fuel are inevitable and higher prices for other energies will quickly follow due to the shift in demand <sup>14</sup> .	<p>Can the proportion of solar and environmental heat energy of the total energy be increased, and the proportion of traded energy sources (electricity, wood, gas, and oil) be decreased?</p> <p>Can impact sound insulation be combined with low temperature floor heating?</p> <p>Can the sound and thermal insulation of the sanitary installations be improved?</p> <p>Can a new electrical installation save energy and be safer in case of fire, lightning strike and water ingress?</p> <p>Can the existing radiators be used in the new heating system?</p>

<sup>12</sup> An impressive example of this phenomenon: The famous architect Charles-Edouard Jeanneret-Gris (Le Corbusier) from La Chaux-de-Fonds, Switzerland built the well-known Villa Savoye near Paris. It is a spacious house that still today, demonstrates an ingenious, modern-looking example of architecture in concrete, steel, and lots of glass. The Villa Savoye was designed and built in the 1920s. Around the same time, a baroque church was built in Melchtal (canton of Obwalden, Switzerland), true to style and traditionally handcrafted (e.g. natural stone walls and carefully carpentered timber trusses)

<sup>13</sup> Recognition of the built environment aids human orientation. Spatial identity stabilizes the occupant's own identity (external memory) and promotes a sense of responsibility toward the physical and social environment (SIA D0200, S.21).

<sup>14</sup> The time when the maximum rate of extraction of non-renewable energy sources is reached and the rate of production declines, is called peak (peak oil, peak gas, peak uranium). The term peak oil is theorized in Switzerland by the historian and peace researcher Dr. Daniele Ganser. In which year global production of conventional oil reaches its maximum is a matter of controversy amongst experts. The German Energy Watch Group concluded that the global peak was already exceeded in 2006. More important than the question as to when exactly global peak oil will occur, is to be prepared for when it will inevitably happen. Because of the peak oil, a significant rise in energy prices is expected (not only for oil). For further information see e.g.: [Energie Dialog Schweiz, 2009]

The building envelope has never been renewed.	<p>Which elements of the building envelope (façades, windows, basement ceiling, attic, or roof) are top priority?</p> <p>Can a cost-effective solution be achieved through a combined renovation of several elements of the building envelope?</p> <p>Which technical and structural problems have to be considered for a renovation that is done in stages?</p> <p>Is a comprehensive renovation the most cost-effective option?</p>
The apartments and accessibility have never been upgraded.	<p>Can a elevator be installed and the bathroom and kitchen be adapted to meet the needs of the elderly?</p> <p>Can small apartments be combined into a larger apartment meeting family housing needs?</p> <p>Can the renewal of kitchen and bathroom, which are still in working order, be done away with in favour of affordable rents to satisfy student housing requirements?</p>

### 5.2.3. Number of apartments

The number of apartments<sup>15</sup> per building<sup>16</sup> has an important influence on the identification of the occupants in their building. In small buildings (two or three family houses), occupants see themselves as a community. They identify themselves with the entire building and protect the property against outside influences. In the case of large multi-family houses (sharp increase for eight or more apartments), and depending on the situation and social structure of the occupants, identification with the property or building can be completely lost [8]. If the occupants only identify themselves with their own apartments, they do not particularly look after the building, or the property as a whole. This means that the maintenance costs of common use areas (e.g. stairwell, laundry rooms, surroundings etc.) can rise significantly.

Situation	Planning questions
Multi-family house with eight or more apartments.	To counteract occupant's loss of identity, can the number of apartments be reduced, e.g. two smaller apartments be combined into a large family or into a luxury apartment?
Multi-family house with three to seven apartments.	If there is no evidence of loss of identity, no action is needed.

<sup>15</sup> All living units (including single- family houses) which have a kitchen or kitchenette are classified as apartments. All apartments that were occupied by a household when the survey was conducted, count as a living unit. If a household occupies two apartments, these are combined to give one living unit. Rooms for special use that belong to the household but are not located in the apartment (e.g. mansards), are also counted as belonging to the apartment. See [3]

<sup>16</sup> Apartments with a common, main access (see definition of a building in chapter 5.3)





Original 1950 staircase of case study building, Lucerne (see chapter 6.5), photo by R. Fischer, HSLU-CCTP



### 5.3. Features of main access<sup>17</sup>

Situation	Planning questions
Inside staircase not running along the inside of the outer wall. There is no elevator.	Can a elevator be installed inside the house?
A elevator is next to the staircase and stops at each landing at storey level.	Is the elevator accessed without steps from the street onwards? Is the elevator wheelchair-accessible?
The stairs run along the inside of the outer wall and have the landing at floor level where the apartment entrances are, but they are not adjoined to the outside wall. There is no elevator.	Can barrier-free access be provided by installing a elevator and access balconies at storey level? Can the ground level apartments be accessed barrier-free (e.g. patio)?

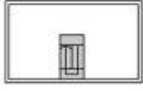
#### Explanation to the types of main access

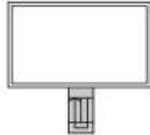
The relevant types of main access base on the two features "Position of staircase in floor plan" and "Position of elevator in floor plan". *For further information see: Building Typology and Morphology [VI]*

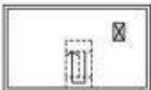
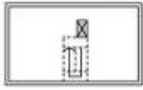
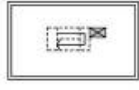
Position of staircase in floor plan		Position of staircase in relation to the ground plan relative to the building envelope.	
			
Staircase in the centre of building.	Inside staircase at outer wall with landing in the centre of building.	Inside staircase at outer wall with landing adjoining outer wall.	Outside staircase.

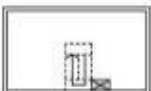
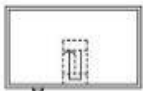
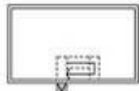
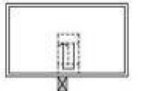
Position of elevator in floor plan		Position of elevator in the ground plan relative to the staircase and the building envelope.	
			
Elevator within the building, not connected to staircase.	Elevator within the building. Direct stair and landing access at apartment level.	Elevator in the centre of the building. Staircase and landing not on apartment level.	Elevator on outer wall. Direct stair and landing access at apartment level.
			
Elevator on outer wall. Stair and landing not on apartment level.	Elevator outside the building not connected to staircase.	Elevator at outer wall with stair and landing access at apartment level.	Elevator outside the building. Stair and landing not on apartment level.

<sup>17</sup> Main access includes access from the public space (street) to the private space (apartment)



Southwest façade of case study building, Lucerne (see chapter 6.5), photo by R. Fischer, HSLU-CCTP

## 5.4. Features of the storeys

### 5.4.1. Height of storeys

Situation	Planning questions
The building has storeys with a height of 2.80 m or more <sup>18</sup> .	Can ventilation ducts be installed inside the building? Can the impact sound insulation be improved by constructing a floating floor?
The building has floors with a height less than 2.70 m.	Can ventilation ducts be installed on the outside walls? Can the impact sound insulation be improved by laying soft floor covering?

### 5.4.2. Storey categories

Situation	Planning questions
The building has storeys that are heated, and fully or partly occupied with apartments.	Can the building shell achieve a more compact design with an extension? <sup>19</sup>
The storeys are partly heated and the upper edge projects over the knee wall of the pitched roof.	Does building legislation allow the addition of more storeys?
The building has one or several upper storeys that are at least partly set back from the façades.	Can the attic be converted to a full storey?
The building has one or several lower storeys that are not heated.	Does the amount of natural light allow the space to be converted into living space?
The building has one or several upper storeys that are not heated.	Can the building be extended upwards? Considering the loss of storage space, is it worth converting the attic?
The building has one or several storeys in which the internal space is reduced to about the same area of the main entrance.	The storey needs to be extended.

<sup>18</sup> The height of the storey includes the ceiling height of the room plus the thickness of the floor above. The ceiling construction is usually about 30 cm thick. This results in a room height of about 2.50 m. A room height below 2.50 m is perceived to be low.

<sup>19</sup> The ratio of the building envelope surface (A) to the energy reference area (ERA) is an important figure for calculating the energy requirement. The building envelope surface (A) is defined as the total surface area of all building parts that separate the heated rooms from the unheated surroundings (walls, roofs, attic floors, cellar ceilings, windows). The ERA is defined as the total area of all heated rooms. The smaller the ratio, the lower is the energy requirement per square meter in the case of the same insulation thickness of the building envelope. The reason for this is the lower proportion of energy loss (through the building envelope) per square meter of energy reference area. Projections and recesses in the façades, complicated roof shapes, and unheated mezzanines have a negative affect on the ration between A and the ERA.



Original 1950 kitchen of case study building, Lucerne (see chapter 6.5), photo by R. Fischer, HSLU-CCTP

## 5.5. Features of the apartments

### 5.5.1. Type of kitchen

For many user groups, the type of kitchen is one of the most important deciding factors when looking for an apartment. Apartments without kitchen or with only a kitchenette, could appeal to weekly residents or for occasional use such as second apartments. For all other types of apartments, size of kitchen and dining area in relation to the number of rooms is a key issue.

Eating and cooking rank highly in society. Correspondingly, ample-sized kitchen diners are important places where meals can be cooked together with family and guests. A generous kitchen diner can replace the living room for user groups with a limited budget. User groups, who have higher expectations and live in a large apartment, can also furnish a separate dining room (in the sense of the traditional, middle-class reception room). A generous kitchen diner also has the advantage of keeping cooking smells out of the rest of the living space. An apartment with a kitchen diner is suitable for everyone, regardless of income. For young couples it is especially attractive, as they do not have to move apartments when they start a family.

Situation	Planning questions
Apartments with small kitchens.	Can part of a large living room be reallocated to the kitchen? Can a large living room and the kitchen be converted into an eat-in kitchen?
Apartments with an combined kitchen-living-dining room.	Can the kitchen and dining area be transformed into an eat-in kitchen and separated from the living area?

### 5.5.2. Living space

Situation	Planning questions
Apartments with small rooms.	To attract new user groups, can several small rooms be combined into one?
Apartments with large rooms.	The apartments appeal to a wide range of contemporary user groups. No measures necessary.
Apartments with large and small rooms.	Can small rooms be combined with larger ones, or with the kitchen?

### 5.5.3. Balconies

For some user groups, the size and number of balconies is an important factor in judging suitability of an apartment. Each apartment should have at least one private outdoor area (patio, terrace, or balcony) which is large enough for a table and two chairs.

Situation	Planning questions
Ground floor balconies	Can the balconies be replaced with patios?
Existing balconies	Can larger private outdoor areas be created?
No private outdoor area	Can a balcony be added?



## 6. Planning and realization phases

*For detailed information on planning and realization phases with prefabricated modules please see Part B in this report and [11] (separate report). A brief overview of the concept of prefabricated retrofit systems is also given in the preface of this report.*

### 6.1. Challenges

The actual construction planning (planning permission, execution) follows for each particular stage. The aim of strategic planning of an advanced retrofit (step I-IV) is to determine a building strategy for the whole lifecycle and plan its realization which may also be executed in stages. Planning phases may have to be repeated at different levels of detail (planning application, construction documentation) and can overlap in an iterative process. Realization of the building strategy can be carried out in several stages. In the case of realization in phases, it is important to carry out detailed overall planning beforehand. This is the only way to ensure that all renovation phases are co-ordinated. The final stage of the advanced strategy is the efficiency evaluation of each finished stage (see chapter 7).

### 6.2. Prefabricated retrofit systems

Different renovation modules of the prefabricated retrofit systems may be combined. Chapter 6.5 shows the case study building at Weinbergstrasse 62 and illustrates the modular concept.

Different building elements, such as roofs, façades, and balconies, can also be retrofitted in individual stages. This is due to the standardisation of the prefabricated module. However, comprehensive renovation is usually cheaper because structural problems that may occur in the unfinished state can be avoided.

*The prefabricated modules can also be combined with non-prefabricated retrofit options (e.g. with conventional external insulation between the prefabricated modules). It is also no problem to combine flat modules (panels) and hollow modules (e.g. new attic floor).*

### 6.3. Flexible in architecture

The module concept offers considerable freedom of design. Standardised construction allows modules to be produced for all standard forms of building envelope. Mounting at the building site must be observed closely (undercuts). As with the façade modules (F), there are also different shapes of roof modules (R) (variations). Technical solutions such as shadowing elements or daylight-optimizing reveals and lintels, can also be incorporated easily and cheaply into the prefabricated module at the factory. In addition, elements for active solar energy use can be integrated in all modules.

Façade and roof modules can be designed freely for the following architecturally relevant points:

- Shape of the module (consider mounting possibilities)
- Recessions and projections (e.g. bays, dormers)
- Measurements of the modules (max. maximal measurements: 3.5 x 3.5 x 12 m)
- Measurement and number of openings
- Design of reveals and railings
- Construction material (wood, wood-metal, metal)
- Cladding material (all standard façade materials are possible)
- Shadowing elements (all standard sun protection systems can be integrated)
- Integration of solar energy (photovoltaic and photo thermal)
- Technical equipment (integrated risers for central ventilation and electrics, decentralized ventilation systems, automatic shadowing systems, integration of solar energy)

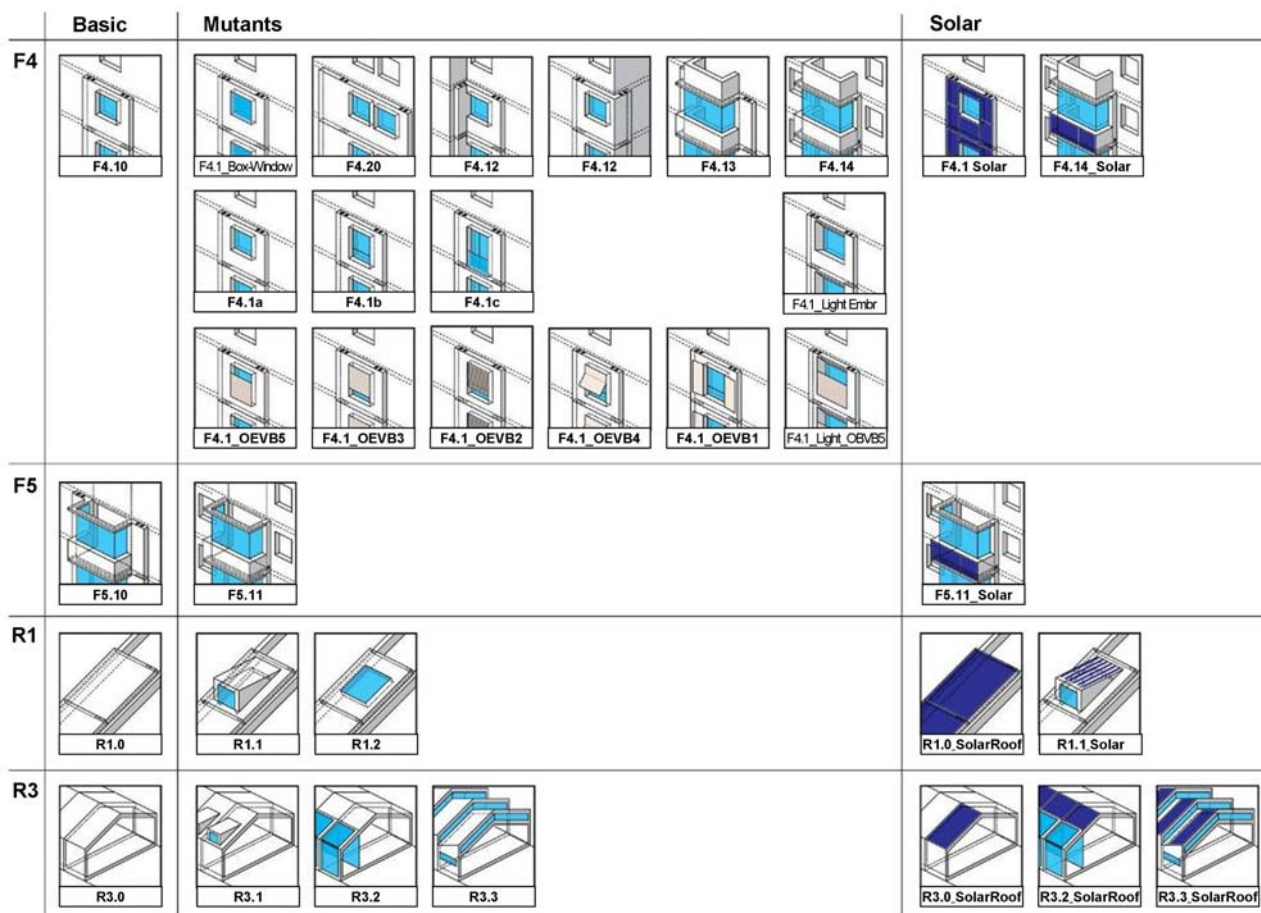

Figure 7: Overview of design variations for prefabricated façade and roof modules

### 6.4. Variation of application and cladding materials

In principle, all types of conventional façade materials can be applied to the standardized construction. Weight has to be considered (e.g. natural stone) and the strength of the design and mounting clamps has to be dimensioned accordingly. Otherwise, the total weight of the façade could become a problem for the existing structure and the foundations. Design preferences and requirements (e.g. cultural heritage protection) have to be contrasted with technical and economic consequences.

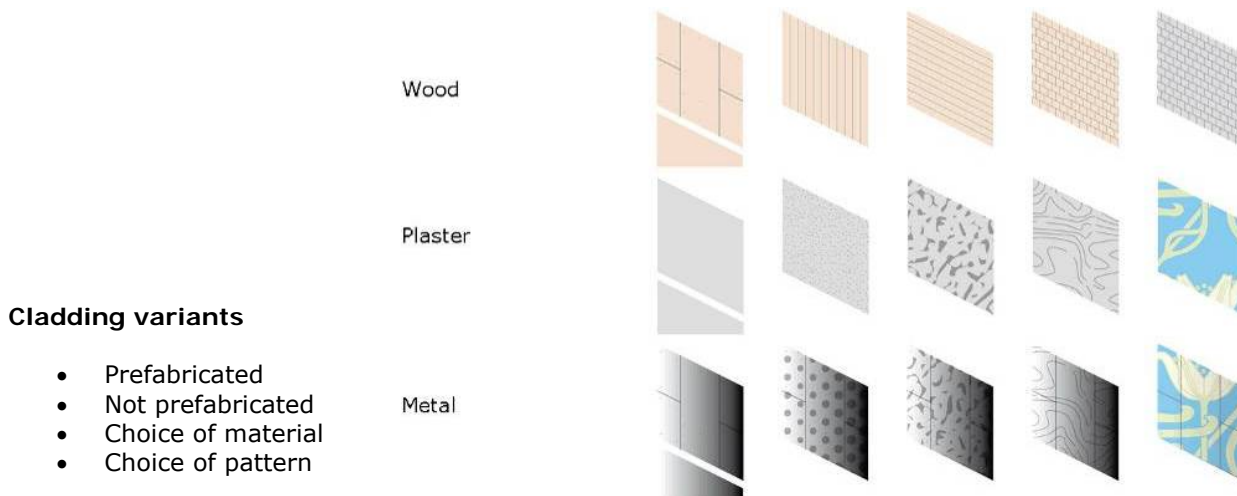

Figure 8: Overview of design variations and façade materials

### 6.4.1. Integration of solar collectors

Freedom of form and façade materials offers exciting possibilities for integrated solar energy use. The façade surfaces of the modules for example, can be tilted to face the sun optimally. The different systems (photovoltaic, photo thermal, flat collectors, tube collectors, etc.) can be installed at the factory. Integrated risers can be used for domestic hot water feed and return, or for electric cables to solar panels.

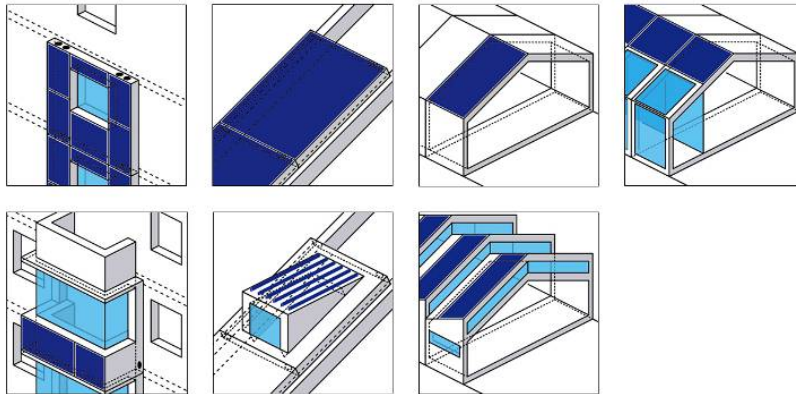

Figure 9: Overview of design options for solar collector integration

## 6.5. Pilot case study Weinberglistrasse 62, Lucerne, Switzerland

Residential buildings in the Elfenau and Sternmatt housing estates feature in the pilot case study to demonstrate a comprehensive renovation option with the prefabricated retrofit system. The most important planned renovation options at a glance:

### Building envelope

- Façade insulation using F4.1\* modules
- Balcony cladding using F5\* modules
- Sloping roof panels R1\* on existing roof truss
- Sloping roof panels with dormers R1.1\*
- New floor heating for the new penthouses (former attic)
- New floor construction with floor heating and VIP insulation for the new offices in the basement (former garages)
- New floor construction with VIP insulation for cellars and stairwells in the basement (not heated)
- Perimeter insulation in the skirting
- New glass front in place of the garage door

### Building technology

- Use of the existing heater for low temperature range
- Central ventilation for all units
- Integrated ducts in F4.1\* modules
- Supply and exhaust airflow via flue of the existing oil heating system
- Tube collectors for heating water

### Units

- Two new offices/ateliers in the basement (in place of garages)
- Six one-bedroom apartments with kitchen diner (in place of two-bedroom apartments with a small, separate kitchen) each with a summer room (in place of a balcony) accessible from both rooms.
- Two new ample-sized one-bedroom penthouses (in place of two studios plus attic)

### Access

- Barrier-free access to all apartments via: Outside ramp, elevator tower (in front of bathrooms) and access balcony

\* see Figure 7 for module types



Figure 10: Cross-section with new building envelope as well as direct heated and indirect heated rooms (hatching)



Figure 11: Southeast elevation (street-side façade with new office rooms in place of garages)

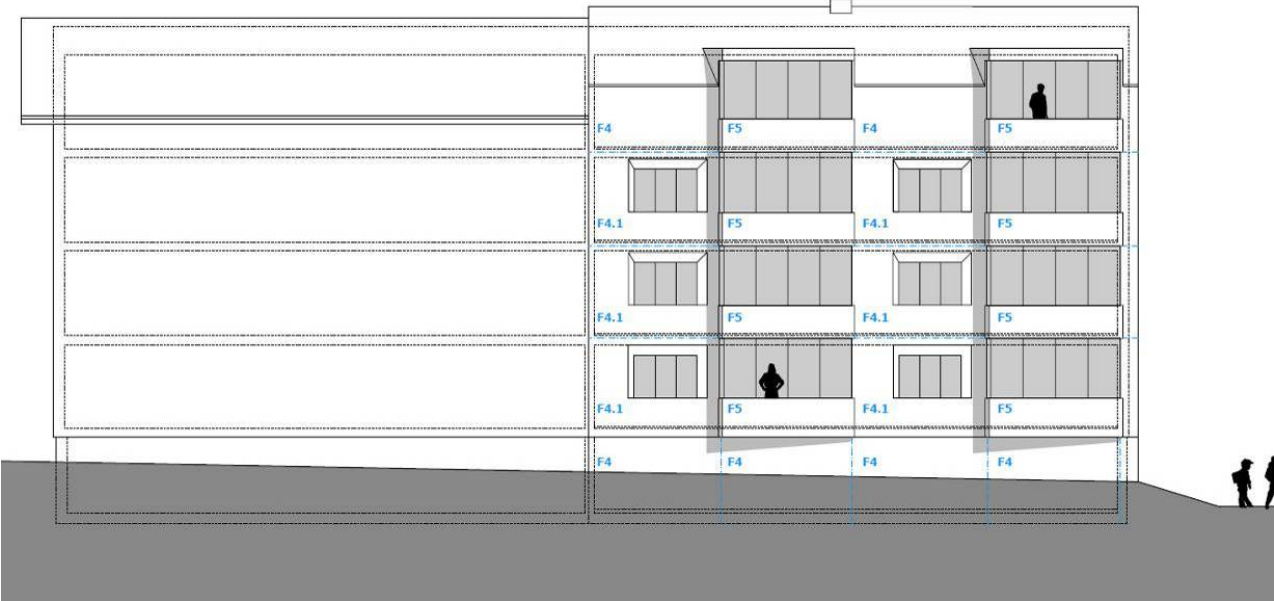

Figure 12: Southwest elevation (with new, glassed balconies)

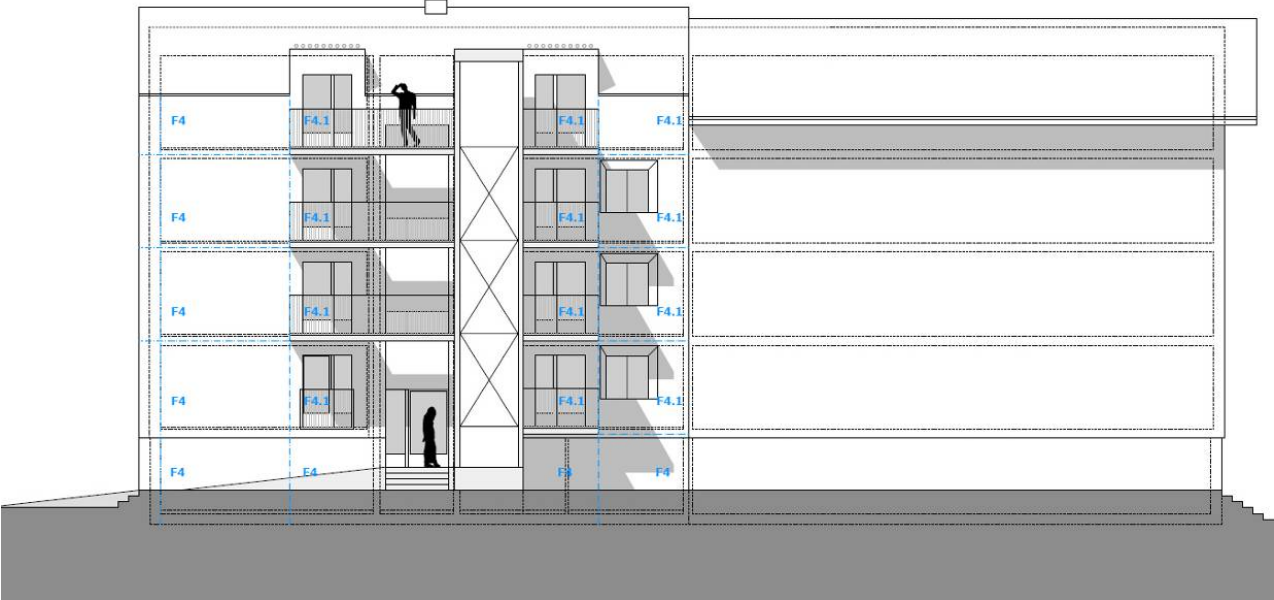

Figure 13: Northeast elevation (Entrance façade with new elevator and access balconies)

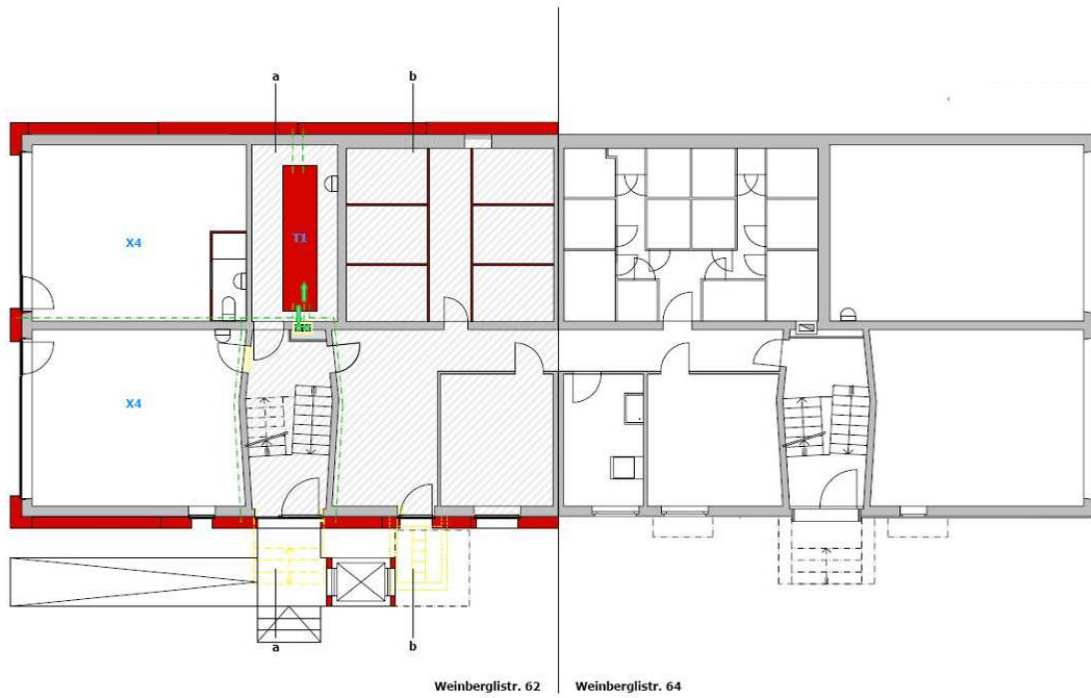

Figure 14: Layout plan of the basement (with new offices instead of garages)

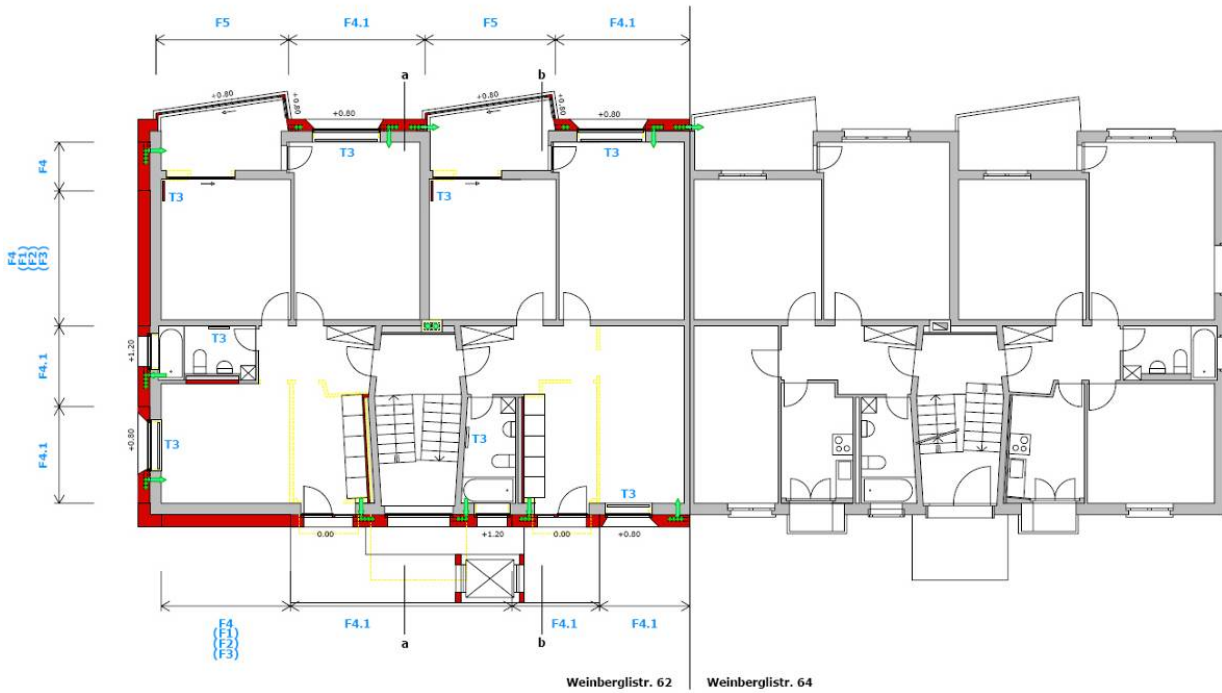

Figure 15: Layout plan of the ground floor, first and second level (with eat-in kitchen instead of small rooms and separate kitchen)

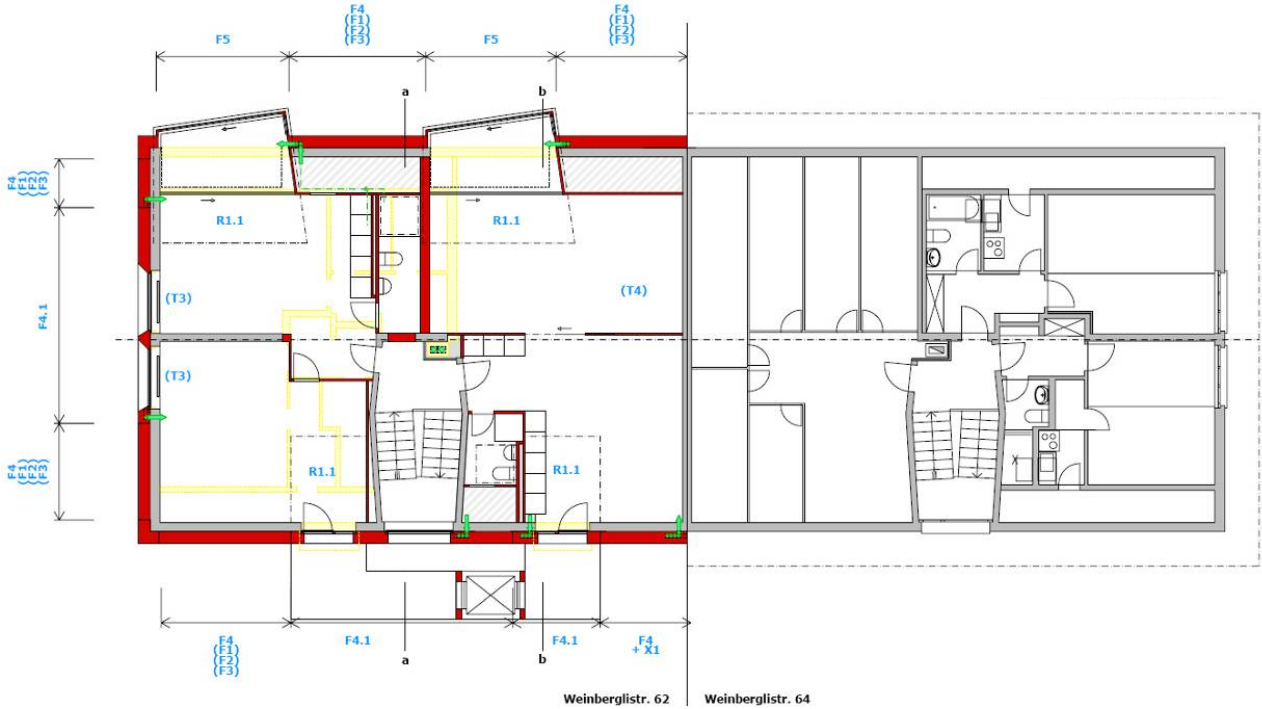

Figure 16: Layout plan of the upper floor (with two ample-sized penthouses)

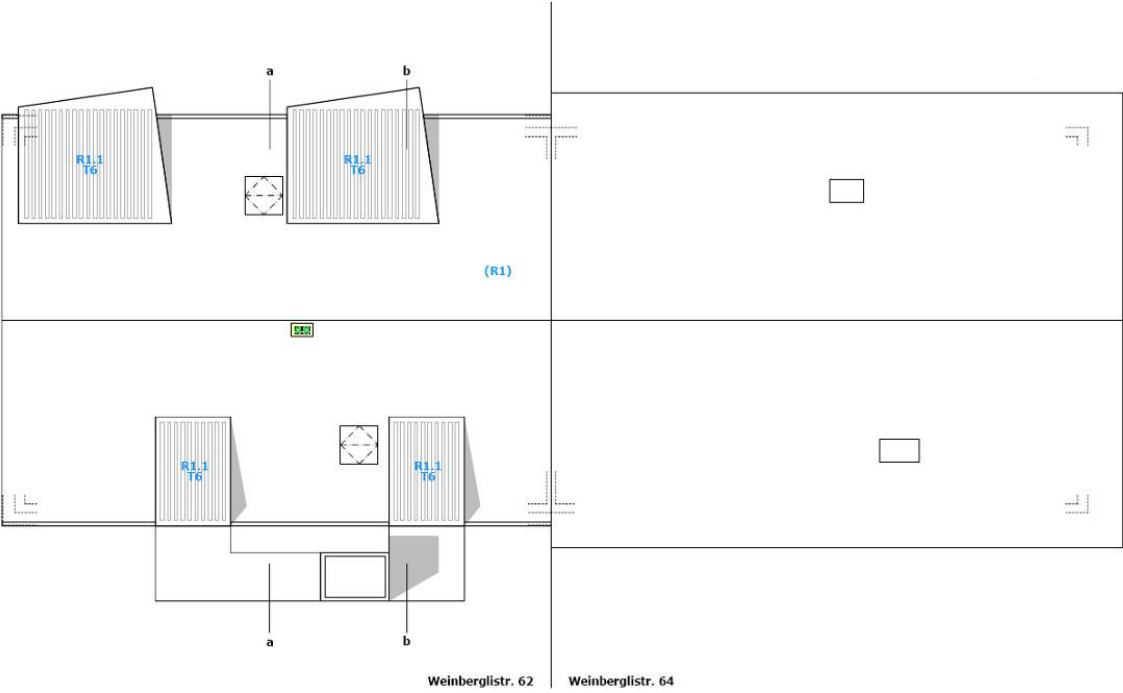

Figure 17: Plan of the roof (with active energy system)

## 7. Evaluation of target effectiveness

Special attention is given to evaluation of the results of an advanced retrofit. The aim of this evaluation is to achieve the best possible learning and improvement effect in planning and realization.

The evaluation of target effectiveness includes the following phases:

1. Feedback discussions of everyone involved (owners, planners, contractors and authorities) on completion of the construction work
2. Monitoring energy use over 1-3 heating periods
3. Conducting a tenant satisfaction survey after 1-3 years

The results of the evaluation flow back into the target agreement (Step IV) and form the basis for the next phases. It is possible that the building strategy (step I) must be questioned because of the results of the evaluation.

## References

Publications within the IEA ECBCS Annex 50<sup>20</sup>:

- [I] Mark Zimmermann: ECBCS Project Summary report "Annex 50 Prefabricated Systems for Low Energy Renovation of Residential Buildings, October 2011
- [II] Peter Schwehr, Robert Fischer, Sonja Geier: Retrofit Strategies Design Guide, ISBN 978-3-905594-59-1, March 2011
- [III] René L. Kobler, Armin Binz, Gregor Steinke, Karl Höfler, Sonja Geier, Johann Aschauer, Stéphane Cousin, Paul Delouche, François Radelet, Bertrand Ruot, Laurent Reynier, Pierre Gobin, Thierry Duforestel, Gérard Senior, Xavier Boulanger, Pedro Silva, Manuela Almeida: Retrofit Module Design Guide, ISBN 978-3-905594-60-7, March 2011
- [IV] Reto Miloni, Nadja Grischott, Mark Zimmermann, Chiel Boonstra, Sonja Geier, Karl Höfler, David Venus: Building Renovation Case Studies, ISBN 978-3-905594-61-4, March 2011
- [V] Mark Zimmermann, Hans Bertschinger, Kurt Christen, Walter Ott, Yvonne Kaufmann, Stefan Carl: Retrofit Advisor, Beta-version, March 2011
- [VI] Peter Schwehr, Robert Fischer: Building Typology and Morphology of Swiss Multi-Family Homes 1919 – 1990, January 2010
- [VII] Bertrand Ruot: French housing stock built between 1949 and 1974, October 2010
- [VIII] Bertrand Ruot: Elements of morphology of collective housing buildings constructed in France between 1949 and 1974, October 2010
- [IX] Gerhard Zweifel: Retrofit Simulation Report, March 2011

Further sources Part A:

- [1] Adler, Michael; Zophoniasson-Baierl (Hrsg.),: Das Haus als Typ. – Basel: Birkhäuser; 2005
- [2] Beobachter, Kompakt: Bauen und Wohnen. Checkliste Eignung der Wohnung, 2008, p. 20.
- [3] BFS: Gebäude, Wohnungen und Wohnverhältnisse. Eidgenössische Volkszählung 2000. – Neuchâtel: Bundesamt für Statistik (BFS); 2004
- [4] Brunner, Beat: Qualitative Aspekte zum Wohnen in der Schweiz 2005. Bundesamt für Wohnungswesen (BWO): – Grenchen, Switzerland; 2007

<sup>20</sup> Further information at home pages: [www.empa-ren.ch/A50.htm](http://www.empa-ren.ch/A50.htm), [www.ecbcs.org/annexes/annex50.htm](http://www.ecbcs.org/annexes/annex50.htm)



- [5] Energie Schweiz: Mehrfamilienhäuser energetisch richtig erneuern. Empfehlungen zur strategischen Gebäudeerneuerung. – Bern: Bundespublikationen (BBL Bestellnummer 805.108); 2008
- [6] Energie Trialog Schweiz (Hrsg.): Energie-Strategie 2050. (Energy Strategy 2050). Impulse für die schweizerische Energiepolitik - Grundlagenbericht. – Zürich: ; 2009:
- [7] Fischer, Robert; Schwehr, Peter: Building Typology and Morphology. Of Swiss Multi-Family Homes 1919-1990. – Luzern: Hochschule Luzern - Technik und Architektur; 2010
- [8] Flade, Antje: Wohnen psychologisch betrachtet. – Bern: Huber; 2006
- [9] Geier, Sonja; Höfler, Karl: 10 Steps to a Prefab Module. Design Guideline. – Gleisdorf: AEE - Institute for Sustainable Technologies; 2011
- [10] Knauf (Hrsg.): Handbuch Sanierung. Intelligente Lösungen für Brand-, Schall-, Wärme- und Feuchteschutz. – Iphofen: Knauf; 2002
- [II] Kobler, René L. et al.: Module Design Guide. Prefabricated Façade and Roof Modules for Low Energy Renovation of Residential Buildings. – Muttenz: University of Applied Sciences Northwestern Switzerland (FHNW); School of Architecture, Civil Engineering and Geomatics; Institute of Energy in Building (IEBau); 2011
- [11] Meier, Martin: Interview. In: renova Invest Nr. 1-2/2008; 2008
- [12] Ott, W.; Kaufmann, Y.: Checkliste nachhaltige Gebäudeerneuerung. für gemeinnützige Wohnbaugenossenschaften. – Zürich: Econcept; 2007



# Part B

# Design Guide

## 10 Steps to a Prefab Module

Author:

DI. Sonja Geier  
AEE - Institute for Sustainable Technologies (AEE INTEC)

Gleisdorf, March 2011

The participation in the IEA ECBCS Annex 50 was funded by:  
Austrian Federal Ministry of Transport,  
Innovation and Technology  
Vienna

## Preface

The participation in the IEA ECBCS Annex 50 is funded by:

### **Federal Ministry of Transport, Innovation and Technology**

Renngasse 5  
1010 Wien  
Austria

Project No.: 811574 (2005-2009)  
Project No.: 824945 (2009-2010)



Contractor:

### **AEE - Institute for Sustainable Technologies (AEE INTEC)**

Feldgasse 19  
8200 Gleisdorf  
Austria



Sources:

All figures by AEE INTEC if not mentioned differently

## Table of content - Part B: 10 Steps to a Prefab Module

<b>Introduction</b>	<b>53</b>
<b>1. Initial situation</b>	<b>55</b>
1.1 Infrastructure and living quality of location	55
1.2 Expansion of outer dimensions	56
1.3 Ranges for access, delivery and mounting	56
1.4 Construction time, season and weather	58
1.5 Feasibility check	59
<b>2. Existing building stock</b>	<b>60</b>
2.1 Primary investigation	60
2.2 Detailed survey and measurement	61
2.2.1. <i>Airtight envelope of existing building stock</i>	61
2.2.2. <i>Load bearing capacity of roof construction, exterior walls and foundations</i>	62
2.3 Feasibility check	64
<b>3. New building envelope</b>	<b>65</b>
3.1. Requirements	65
3.2. Range of possible alteration and optimisation	66
3.2.1. <i>Modifications of window-sizes</i>	66
3.2.2. <i>Integration of balconies and living space extension</i>	67
3.2.3. <i>Access (barrier-free and escape-routes)</i>	68
3.2.4. <i>Loft conversion or extension</i>	69
3.3. Occupancy during construction works	69
3.4. Cleaning and maintenance	70
3.5. Feasibility check	70
<b>4. Fire prevention</b>	<b>71</b>
4.1. Risk analysis and overall fire prevention concept	71
4.2. Fire prevention of the new building shell	72
4.2.1. <i>Fire behaviour of implemented material</i>	72
<i>Fire resistance of components</i>	73
4.2.2. <i>Spreading of fire and fume between existing walls and new façade systems</i>	73
4.3. Cable run and installation	75
4.4. Feasibility check	76
<b>5. Sound insulation</b>	<b>77</b>
5.1. Requirements	77
5.2. Sound insulation against outdoor sound	78
5.3. Sound insulation within the building	79
5.4. Sound insulation for housing technologies and installations	80
5.5. Feasibility check	81
<b>6. Building physics and ecology</b>	<b>82</b>
6.1. Thermal quality	82
6.2. Moisture prevention	83
6.3. Airtight envelope	84
6.4. Ecological assessment	85
6.5. Feasibility check	86
<b>7. Basic module kit</b>	<b>87</b>
7.1. Basic design concept	87
7.1.1. <i>Specification of module sizes</i>	87
7.1.2. <i>Specification of module orientation and sequence</i>	87
7.2. Integrated components	88
7.2.1. <i>Windows and glazings</i>	88
7.2.2. <i>Shading systems</i>	89
7.3. Technical approval	91

<b>8. Joint and fixing techniques</b>	<b>92</b>
8.1. Module-chain and fixing	92
8.2. Structural design	93
<b>9. Service module kit</b>	<b>97</b>
9.1. Installation concept	97
9.2. Integration in basic module kit	98
9.3. Accessibility	99
<b>10. Active module kit</b>	<b>100</b>
10.1. Active energy generation within building envelope	100
10.2. Interference factors for solar gains	101
10.3. Grid integration and synergies with neighbours	103
<b>11. References</b>	<b>104</b>

## Introduction

A significant part of our energy consumption is caused by existing buildings built between 1945 and 1980. The energy-performance of these buildings is poorer than of all others. Therefore the key focus in this field should lie on the development and implementation of innovative renovation-concepts in order to improve the energy-efficiency of this building stock. Advanced retrofitting needs comprehensive concepts, regarding the entire envelope as well as building services, energy-efficiency measures and the integration of renewable energy sources. In order to improve the thermal performance generally thick layers of insulation are needed and thermal bridges have to be eliminated to the greatest extent. Critical success factors are the adaptation of already approved passive house technologies (for new buildings) and their economic implementation within renovation procedures. So it is important to find repeatable solutions, which offer more advantages than only an insulated building shell.

### Focus on application of prefabricated modules within renovation

Prefabrication offers a production process with a controlled quality standard. The majority of the construction phase is not dependant on weather conditions. This enables serial production of standardized modules, a much shorter construction period and less discomfort for tenants during the construction phase. The utilization of renovation concepts is not wide-spread at the moment. Currently a common and economic renovation method– even to reach passive house standard – is to bring up a composite heat insulation system. Concerning this method, however, no further development or improvement is possible. The thickness cannot be increased any more because of the hazard of freezing condensate on the outside of exterior walls during winter. Even if there are a lot of “best practice” projects for building-integration of solar thermal collectors within new buildings – the development of prefabricated modules is in an early stage of development. Advanced prefabricated module kits are able to contribute to economic feasible and sustainable renovation, which offers further on advantages for builders and occupants.

### 10 steps towards a prefab renovation module

However, the challenge within renovation is the existing building stock. Prefabricated modules can be a good solution for exterior insulation – but various requirements have to be considered. And – they are not always the appropriate solution. Building lines or bad access to the building site can block the implementation of prefabricated modules. But how is it possible to find an optimized solution, considering all possible conditions and requirements?

A guideline for the implementation of multifunctional renovation modules should be provided to builders, planners and manufacturers in order to support their decision-making and during the planning and production process. Assistance is offered to different subject groups, split into 10 steps. Following the questions and objectives in each step, it is possible to get a comprehensive perspective on key points, which should be considered.

The **first 6 steps** should support the decision about an appropriate renovation concept – whether it is a composite heat insulation system, a rear ventilated façade, a partly or a fully prefabricated module system. Three different options for renovation strategies are the façade solutions F1, F2 and F3. These are not fully prefabricated and may be sometimes the best solution for a renovation concept. A detailed description can be found in the Module Design Guide [III]. At the end of each step - respectively chapter - a **feasibility check** should offer assistance to choose the right system and show the advantages and disadvantages. If each of these steps shows a majority of advantages for a prefabricated module system it might be a good solution.

But the path to a prefabricated module system is not completed until the steps 7-10 – which guide on the further path towards a renovation module. This is option F4 - a fully prefabricated façade module. Several prefabricated solutions have been developed within the IEA ECBCS Annex 50. A more detailed overview is shown in the Module Design Guide [III].

			
<b>External thermal insulation composite system (ETICS)*</b>	<b>Rear ventilated façade system</b>	<b>Façade system – partly prefab</b>	<b>Prefab module system</b>
<i>Common insulation measure – manually brought up insulation panels, covered with reinforced priming material and a plaster coating, which is coloured.</i>	<i>Insulation brought up between laths or other substructure, fixed with mounting system, covered by various claddings. Entire assembling procedure carried out manually.</i>	<i>Assembly of prefabricated substructure, filled with blown-in insulation. Cladding whether integrated in prefabricated system or manually brought up afterwards.</i>	<i>Fully prefabricated modules, assembled in fabrication hall, transported on-site and mounted on prepared sub-structure onto façade. Serial production possible.</i>
F1	F2	F3	F4

Table 1: Typology of façade renovation systems

\* ETICS is the abbreviation for “External Thermal Insulation Composite Systems”

Advanced renovation needs multi-functional prefabricated modules – in the right place at the right time. The development of different solutions for prefabricated modules in the Annex 50 is an initial point – the experiences and lessons learned within this research project are summarized in the “10 steps” and give assistance for advanced module development. The practical supply of the key parties involved in the renovation process helps to make today’s pilot projects a tomorrow’s standard.

Enjoy your way towards a prefabricated renovation module!

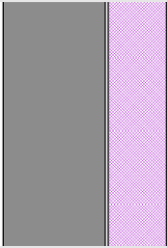
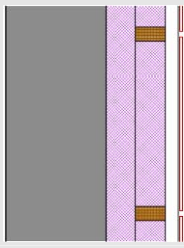
Gleisdorf, March 2011



# 1. Initial situation

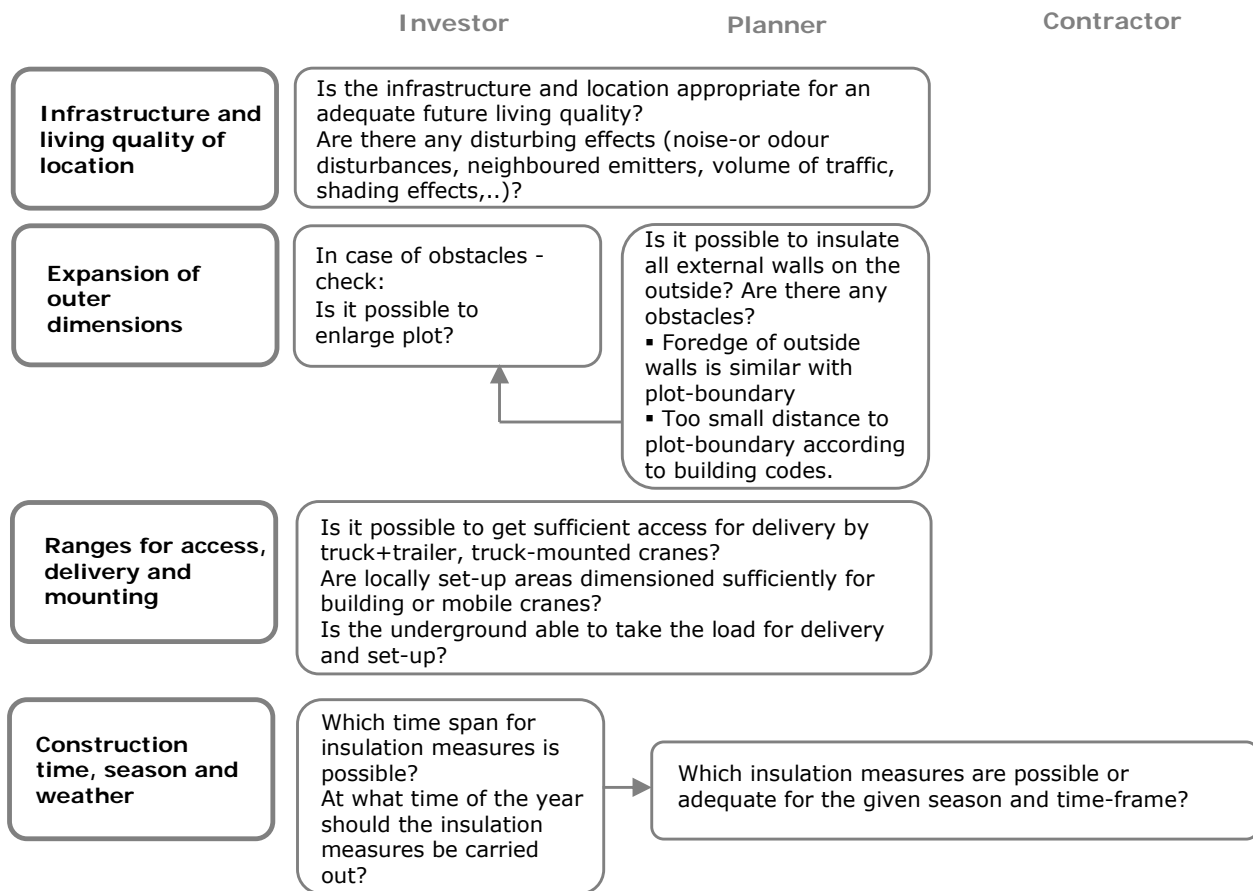

## 1.1 Infrastructure and living quality of location

Housing and settlement policy should focus on an optimized development of existing and new buildings. Sometimes it could be better to demolish and build new housing estates on locations of better infrastructural equipment and higher living quality. Particularly big housing owners, housing associations or public entities operating buildings do have a broader portfolio of buildings with different base levels. Looking on a building park it is on a long term more sustainable and economic to select buildings of higher infrastructural and living quality for further improvement or renovation.

Important benchmarks are:

- Connection with technical infrastructure (supply of water, effluent disposal, power,...)
- Distances to commercial, educational, administrative and social infrastructure
- Access and distances to mobility infrastructure (public transport system)

But furthermore it is essential to identify possible disturbing effects, which may influence the living quality like:

- Noise- or odour-disturbances
- Neighboured emitters, which exceed customary in a place emerging emissions
- Volume of traffic like highways, streets, railway lines the frequency and distance of which imply disturbing noise
- Power lines or magnetic alternating fields (mobile phone antennas) which are within 100 m far from plot-boundaries

➔ Main issue is to evaluate if the quality of the surrounding is appropriate for a future sustainable and high-quality living environment.

## 1.2 Expansion of outer dimensions

Common renovation strategies focus on insulation measures on the outside of the existing building shell. Many building physics aspects can be fulfilled more easily - than by insulation of the internal wall surface. But bringing up insulation on the outside leads to thicker walls, an expansion of the outer dimensions, the gross floor area is increased and distances to plot-boundaries or frontage lines are shortened. Depending on building codes or local master plans barriers to bring up an exterior insulation may occur.

Therefore two essential issues have to be clarified:

- Does the existing distance to the plot-boundary or frontage line allow an exterior insulation?
- Which scale of increase of the outer dimension is possible according to legal regulations?

Regarding possible restrictions several possible alternatives can be considered. Sometimes the building code defines a possible exceeding of plot-boundaries to a certain scale if an insulation measure is implemented. Otherwise it could be possible to enlarge the plot and find an agreement with the neighboured owner (trade-off,...).

➔ Main issue is to check if it is possible to bring up an exterior insulation system.

## 1.3 Ranges for access, delivery and mounting

Every improvement of the thermal envelope on the outside has a certain space requirement depending on the chosen measures. Composite heat insulation measures or small-scaled façade systems, which are brought up and installed manually, need only the space for scaffolding. Façade systems depending on heavy and large-scaled components require more space for delivery and sufficient access with trucks, truck and trailers or low-loaders close to the façade makes the installation works easier and quicker. As well additional lifting gears enable smart proceedings. There is a broad variety of possible auxiliaries even for hard-to-reach area, but in urban areas of high density or interior courtyards constrictions might occur. Hence an on-site inspection or a site plan shows the options.

Practice- and security-oriented assistance for planning scaffolding work can be found within the website of the Austrian accident insurance group under following link:

[http://www.auva.at/mediaDB/MMDB130137\\_M262.pdf](http://www.auva.at/mediaDB/MMDB130137_M262.pdf)

*International product ranges for lifting, loading and handling tools:*

<http://www.vertikal.net/en/access-lifting-directory/>

*Software-tool for crane-operation:*

<http://www.cranimax.com>

*Product-ranges for small cranes:*

[http://www.minikran-mieten.de/Mietgerate\\_Minikran\\_Vermietung/mietgerate\\_minikran\\_vermietung.html](http://www.minikran-mieten.de/Mietgerate_Minikran_Vermietung/mietgerate_minikran_vermietung.html)

Heavy and large-scaled components need accessibility for trucks, trucks and trailers or low-loaders. To get a general idea of a common delivery the dimensions of a so-called "Euro-truck" may help:

The "Euro-truck" is defined within the EU and is valid in most of the European member states. The maximum width (without exterior mirrors) is 2.55 m and the maximum height is 4.0 m. Basically the length is restricted to 18.75 m (articulated lorries 16.50 m).

To check whether an existing access (e.g. street, place) is sufficient an approach of 3.0 m wide and every turn 5.0 m and offer 11.0 m curve radius can be estimated.

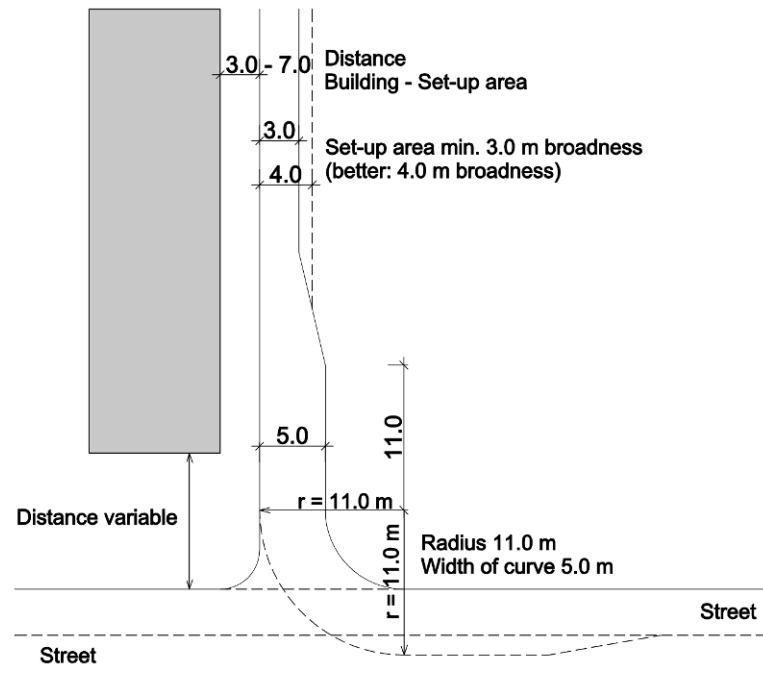

Figure 1: Range for access by truck - basic estimation

For detailed considerations on sufficient access tractrix curves for specific vehicles can be used as templates or by means of various software-tools:

Tractrix curves for articulated lorries can be found under the following link:

<http://www.vif.lu.ch/index/download/schleppkurven.htm>

Tractrix curves for busses and trucks can be found under the link:

[http://faiweb09.bl.ch/~web906/uploads/media/RL\\_Schleppk-Bus\\_01.pdf](http://faiweb09.bl.ch/~web906/uploads/media/RL_Schleppk-Bus_01.pdf)

Various software tools, which can be adopted for several CAD-tools:

<http://schleppkurven.com/index.php?showme=Schleppkurven&vonmenu=>

During the renovation of the residential area "Dieselweg" in Graz large-scaled prefabricated modules were brought on-site. The sequence shown in Figure 2 presents an overview on this kind of assembling procedure.

➔ Main issue is to check whether it is possible to deliver and mount large-scaled modules or not.



Figure 2: Assembling procedure of prefabricated façade modules within the renovation “Dieselweg”, Graz-Liebenau (Source: gap-solution)

### 1.4 Construction time, season and weather

Currently common renovation concepts are based on composite heat insulation systems. The main work is to bring up small-scaled components and several layers of priming materials and surfacers, so it is a manual work and the performance quality is mainly dominated by the crew working on-site. Additionally a technically correct workmanship has to fulfil a series of standards and processing guidelines.

ÖNorm B 6410:2004	External insulation composite systems - processing
DIN 55699:2005 02	Processing of external insulation composite systems

Table 2: Selection of relevant standards for external thermal insulation composite systems (ETICS) processing in Austria and Germany

<a href="http://www.waermeschutz.at/publikationen.php">http://www.waermeschutz.at/publikationen.php</a>	Qualitätsgruppe Wärmedämmverbundsysteme: “Verarbeitungsrichtlinie für Außenwand-Wärmedämm-Verbundsysteme”, Edition 08/2007
---	--

Table 3: Processing guidelines available in Austria

These guidelines define restrictions - beside others – for the realisation of composite heat insulation system concerning:

- Rain without additional protection measures
- Temperatures (Ambient, subsurface, component) below +5°C (for silicate plaster sometimes min. +7°C)
- Temperatures above +30°C
- Direct sunlight (without protecting measures)
- Wind
- Surface irregularities out of allowable deviation

Furthermore the procedure of bringing up composite heat insulation systems requires – after gluing and priming - necessary drying and cure time. During the entire time span the scaffolding remains in front of the façade and windows and doors are sealed with plastic foil. Therefore it is essential to decide – if it is not tolerable for tenants to be surrounded with scaffolding or not to be able to open the windows for a long time – the renovation concept has to be adopted.

Furthermore it has to be considered if weather conditions may effect the renovation works (construction time in late autumn or winter or during summer) – maybe the executing phase is longer because of longer drying times or additional protection measures have to be considered.

Basically, every partial or complete prefabrication needs a more detailed and precise planning and preparation phase. It is necessary to go into greater detail and if the existing structure the complexity is rising. But in the end if it is necessary to reduce the realisation time span on-site and to reduce discomfort and disturbance on occupants, who remain in their apartments, the integration of prefabricated components contribute to smart and shorter proceedings.

➔ Main issue is to check which renovation concept is possible to meet planned time-span and season of scheduled renovation works.

## 1.5 Feasibility check

	 <b>ETICS</b>	 <b>Rear ventilated façade system</b>	 <b>Façade system – partly prefab</b>	 <b>Prefab module system</b>
<b>Delivery</b>	Truck - Standard	Truck - Standard	Lorry or truck - dependent on module size	Lorry or truck - dependent on module size
<b>Areas for set-up and mounting</b>	Area for scaffolding necessary	Area for scaffolding necessary	Building, mobile or truck-mounted crane	Building, mobile or truck-mounted crane
<b>Weather</b>	Renovation work depends on dry weather, mode- rate sun-shine and temperatures over 5°C	Renovation work only partly dependent on weather	Renovation work only partly dependent on weather	Renovation work nearly independent of weather

Table 4: Logistical criteria for system selection

## 2. Existing building stock

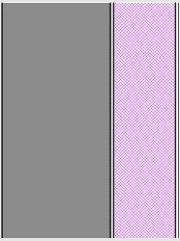
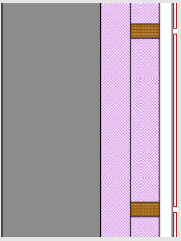
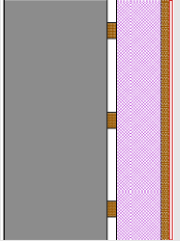
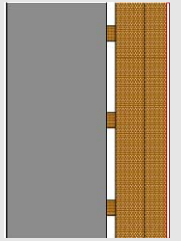
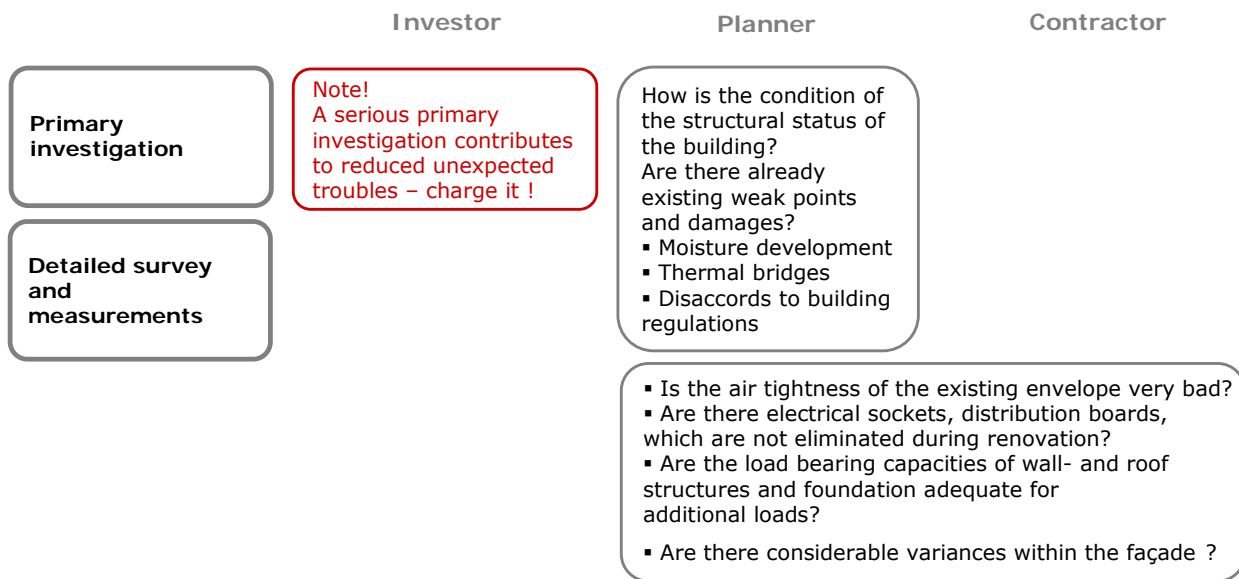

### 2.1 Primary investigation

Renovation means to grapple and deal with existing building structures. Every conception of a renovation concept is based on a thorough primary investigation of this existing substance of building structures. Critical or adverse incidents during the further work can be avoided if the renovation concept reacts on existing conditions.

Generally the building stock built between 1945-1980 (post-war period and time of economic boom) is characterized by a great demand on immediately available and cheap living space. Therefore in many cases the building typology has similar structures. A lot of basic set-ups, the way of construction and selection of materials are typical for this period. But the challenge to succeed in realizing new and affordable living space was bigger than the concernment on the future energy demand of these buildings.

#### Note!

It is essential to investigate the material and physical structure of building components. Therefore accessibility to all parts of the component is necessary but not often possible (e.g.: The opening of structural units like floor covering or roof structures inside occupied apartments). A very useful guideline is the Austrian "Handbook for energy consultants – Fact sheets for constructions in old buildings" („Handbuch für Energieberater“– „Datenblätter für Altbaukonstruktionen und Rechenwerte“ [1]).

Due to the characteristic way of construction in between 1945-1980 a series of typical thermal weak points was created, which can be found as a common thread for this epoch and are now a big challenge for every renovation.

Figure 3: Typical thermal bridge of a projecting roof with an concrete attic

(Source: Architect Erwin Kaltenegger)

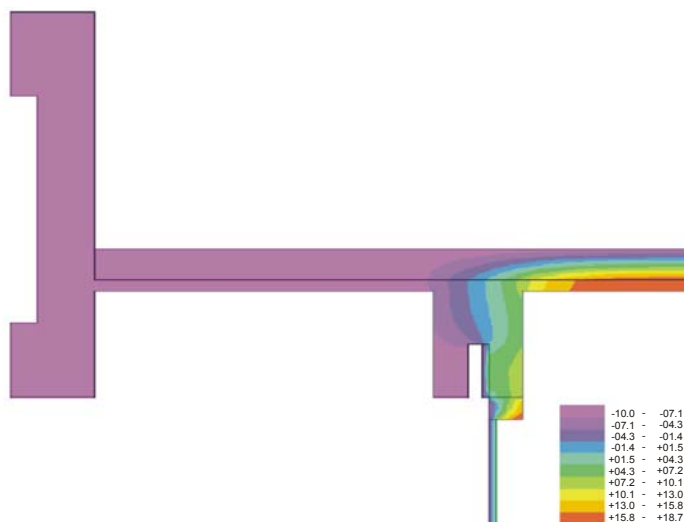
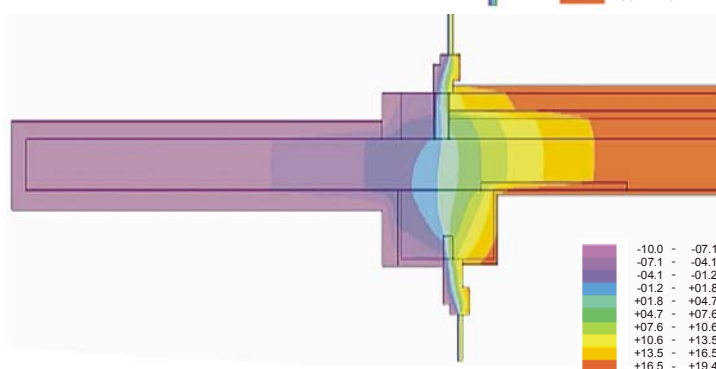

Figure 4: Typical thermal bridge of an concrete slab reaching out without thermal separation

(Source: Architect Erwin Kaltenegger)



Some classic thermal bridges come up with reaching out concrete components without thermal separation, e.g.: balcony slabs or projecting roofs. The hype to build flat roofs created further thermal weak points – the attics were sparsely insulated or not insulated at all.

➔ Main issue is to identify the requirements for renovation works.

## 2.2 Detailed survey and measurement

### 2.2.1. Airtight envelope of existing building stock

The approval of the airtight envelope is now a well-known quality assurance measure after completion of construction works. The advantages of air tightness range from the avoidance of moisture-related building damages to reduced infiltration, heat losses and a basic requirement for optimized ventilation systems.

The influence of air tight envelopes on reduced heat losses is essential: The Austrian “*klima:aktiv*” – criteria catalogue points out that an improvement of the air tightness from 3.0 h<sup>-1</sup> down to 1.5 h<sup>-1</sup> leads to a reduction of the heat demand to about 5.5 kWh/(m<sup>2</sup>·y) [2].

Comparative studies [3] within the renovation of large-volume buildings show large divergences between predicted data and monitored data of the calculated heating demand and consumption afterwards. Further inquiries in this showed that not approved default-values of air tightness and not eliminated leakages cause these differences.

Hence a so-called “Blower Door”-test should be part of a detailed investigation of the existing building structure as well as the following identification of existing leakages. Weak points may be electric wiring, existing breakthroughs (chimneys, pipe network,) or wiring boxes and distribution panels.

This detailed survey is an essential basis for planning the position of the air tight envelope after the renovation. Mostly it is difficult, because not every building component or network is renewed – so some leakages may remain and cause infiltration against expectation.

➔ Main issue is to identify possible weak points within airtight envelope.

### 2.2.2. Load bearing capacity of roof construction, exterior walls and foundations

The structural strength of the existing building structure (load bearing capacity of exterior walls and foundation, roof construction) has further influence on the renovation concept of the thermal envelope.

Basically the building structure is a massive or a skeleton construction system. A very common way of construction for the buildings between 1950 - 1980 was to use reinforced concrete construction. Either the reinforced concrete was used for the skeleton and afterwards filled with masonry or the entire construction was made of haunching concrete. A third possibility – in the later periods – was the plate construction type, which was also dominated by reinforced concrete.

As already mentioned before – nearly all slabs were made of reinforced concrete and reached out without thermal separation on balconies and projecting roofs.

Concrete	
<b>Classification</b>	Strength classification according to Eurocode 2 (exemplary): C16/20, C20/25, C30/37 Due to ingredients or additional reinforcement
<b>Types</b>	Cast-in-place concrete / precast concrete units/ haunching concrete Reinforced / on-reinforced concrete Light-weight concrete / standard concrete / heavy weight concrete
<b>Characteristics</b>	High compressive strength, low tensile strength Tensile strength reached by reinforcement
<b>Important</b>	Any existing concrete construction must be evaluated as “cracked” without static approval. Gravel nets, hollows and cracks influence load bearing capacity.
<b>Recommendation</b>	Stress test and test drilling to approve actual bearing capacity.

Masonry	
<b>Classification</b>	Classification due to used the brick, the construction (single-shell, to-with) strength calls and cross-density of bricks.
<b>Types of bricks</b>	Solid brick, vertical coring brick, hollow blocks made of concrete or light-weight concrete, ...
<b>Characteristics</b>	High compressive strength, no tensile strength
<b>Important</b>	Masonry of unknown material without static approval has to be treated as not bearable.
<b>Recommendation</b>	Load tests and boreholes on-site

It is a common characteristic of all massive constructions that they are good in carrying compressive loads, but worse in taking over tensile loads.

The compressive load capacity of walls depend both on the above mentioned characteristics and on the slenderness ratio (height: thickness) of the wall and on stiffening partition walls. Wall constructions made of reinforced concrete are – depending on the reinforcement) also able to take over tensile loads. But it is assumed to be difficult to prove the actual ratio and position of reinforcements.





Figure 5: Building stock – solid construction



Figure 6: Building stock – plate construction type (Source: Ziv. Ing. Büro Boder)



Figure 7: Building stock – skeleton construction (Source: LIG Steiermark)

Every additional load of a new thermal envelope has to be taken over by the existing bearing structure – down to the foundation. Therefore it is very essential to know the load bearing capacity of the foundation. The capability depends on the size of the existing foundations as well as on the soil pressure capability. Therefore a careful approval by a static engineer is decisive to avoid further subsiding and consequential effects like cracks or collapsing constructions.

➡ Main issue is to prepare the fundamentals for a structural concept of a new façade system.

Evenness of underground (exterior walls, façade) Another key aspect is to assess the evenness of the subsurface. Composite heat insulation systems are partly able to equate uneven façades, but there are allowable deviations defined by standards and workmanship-guidelines. Table 5 shows permissible limits given by the ÖNorm DIN 18202; any unevenness above these limits can be compensated by several prevail achievements (like manually brought up priming material) but it is affordable and needs additional time.

	Limited height [mm] at reading point distance [m]				
	0.1	1	4	10	>10
<b>Walls with unfinished surfaces</b>	5	10	15	25	30
<b>Walls with finished surfaces</b>	2	3	8	-	-

Table 5: ÖNorm DIN 18202 (Tolerances for surfaces of composite heat insulation systems)

Curtain walls or prefabricated façade elements need also even façade-surfaces. Large-scaled prefabricated components are even more sensitive due to uneven surfaces. But due to their way of construction they are mostly installed upon a substructure. This substructure can compensate uneven subsurface more easily and – it has to be mounted somehow. No additional effort is necessary.

The identification of the dimensions of the façade is important, but large-scaled and prefabricated components need very high quality data. Currently a common method is based on digital measurements, e.g.: 3D-laserscanning delivers 3-dimensional point clouds, which can be transferred to CAD-tools for further planning.

➡ Main issue is to prepare the fundamentals for a fixing concept of a new façade system.

## 2.3 Feasibility check

	 <b>ETICS</b>	 <b>Rear ventilated façade system</b>	 <b>Façade system – partly prefab</b>	 <b>Prefab module system</b>
<b>Thermal characteristics</b>	Thickness of insulation layer is limited (freezing condensate).	Possibility of rear ventilation (useful considering moisture properties or to deal with soaked walls)	Possibility of rear ventilation (useful considering moisture properties or to deal with soaked walls)	Improved U-values possible (depending on layer composition)
<b>Constructive characteristics</b>	No substantial additional loads for existing walls.	Existing wall and foundation has to be proved due to their load bearing capacity.	Existing wall and foundation has to be proved due to their load bearing capacity.	Existing wall and foundation has to be proved due to their load bearing capacity. Possible to compensate by new system for load suspension.
<b>Surface conditions</b>	Surface has to be in the range of evenness-tolerance. In case of crumbling plastering additional fixings are needed.	Uneven façade surfaces can be compensated with substructures.	Uneven façade surfaces can be compensated with substructures.	Uneven façade surfaces can be compensated with substructures.

Table 6: Applicability check for façade renovation systems

### 3. New building envelope

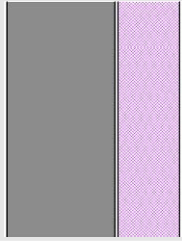
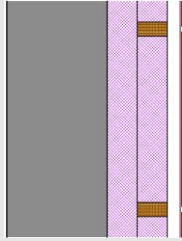
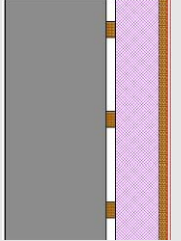
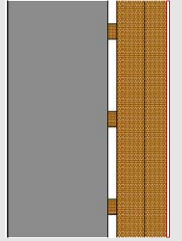
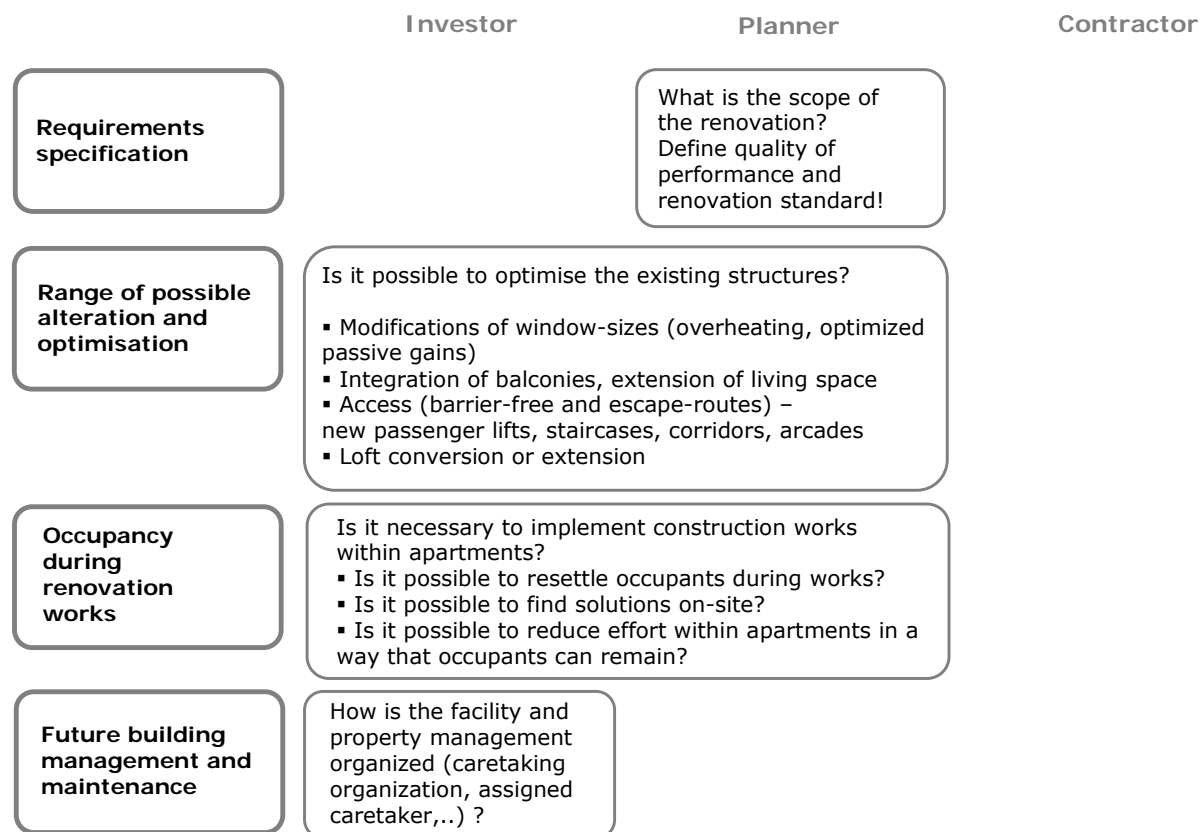

#### 3.1. Requirements

The main issue within renovation of buildings to energy-efficient buildings is to define the level of renovation standard. Furthermore it is necessary to agree on objectives for further planning. Comprehensiveness and thickness of the new thermal envelope, necessary energy efficiency measures as well as the entire energy concepts are influenced by the chosen level. For example: Renovations targeting about 60% percentage improvement of the heating demand can be done with current common “standard renovations”. A “standard renovation” might include the bringing up of a composite heat insulations system in combination with new passive house windows, the elimination of some significant thermal bridges and insulating the cellar ceiling and the top floor ceiling. But in order to reach high performance renovation it is necessary to change the renovation system, to integrate ventilation systems with heat recovery and to eliminate consequently all thermal bridges [3].

High performance renovation levels can be defined individually. It depends on the energy policy of the investor or builder, as well as the possible necessity to fulfil requirements in order to get subsidies. In middle-European countries the “passive house” standard is well known, while in Austria a variety of criteria catalogues within the Austrian programme “klima:aktiv-haus” or “klima:aktiv-passiv haus” is wide spread. In Switzerland “Minergie” and “Minergie-P” is used.

<b>Passive house standard</b>	<a href="http://www.passiv.de">www.passiv.de</a>
<b>Austrian criteria catalogues within “klima:aktiv”</b>	<a href="http://www.klimaaktiv.at">www.klimaaktiv.at</a>
<b>Swiss “Minergie” and “Minergie-P ®”</b>	<a href="http://www.minergie.ch">www.minergie.ch</a>
<b>German EnEV</b>	<a href="http://www.enev-online.de">www.enev-online.de</a>

Table 7: Further information on voluntary standards for renovation

The relevant key indicators for the passive house standard, which is very well known for new buildings and often used as well for renovations in Europe are summarized in Table 8.

<b>Heating demand</b>	HWBWNF $\leq 15$ kWh/(m <sup>2</sup> ·y)
<b>Primary energy-indicator (incl. household electricity, appliances,...)</b>	$\leq 120$ kWh/(m <sup>2</sup> ·y)
<b>Primary energy-indicator (Heating, DHW, auxiliary)</b>	$\leq 40$ kWh/(m <sup>2</sup> ·y)
<b>Heating load</b>	$\leq 10$ W/m <sup>2</sup>
<b>Air tightness of building envelope</b>	n <sub>50</sub> $\leq 1.5$ h <sup>-1</sup>

Table 8: Overview of relevant indicators required to reach passive house standard according to "PHPP 2007" [4]<sup>21</sup>

➔ The definition of specific targets and key indicators allow a better quality assurance during construction works and after completion.

### 3.2. Range of possible alteration and optimisation

Existing buildings are restricted within their possibilities for substantial alterations especially if they are occupied. During a thorough investigation some weak points may arise and it should be checked if there are possibilities to eliminate them by renovation or not:

- Decrease of window or glazing size (in case of overheating problems)
- Increase of window or glazing size (in case of too less natural lighting inside rooms)
- Thermal bridges caused by balcony slabs
- New (barrier-free) access infrastructure (elevators, staircase, corridors,..)
- Loft conversion or extension

#### Note!

The flexibility of adaption of a renovation concept may differ depending on the chosen system for the new thermal envelope. Within composite heat insulation systems it is possible to make alterations anyway - increase or decrease opening sizes by brick-laying, or breaking through parapets), to enlarge small rooms by building up new floors and walls – but you need additional manual workmanship for brick-laying and concrete works or you have to introduce a second system – maybe semi-or prefabricated. The same arguments are true, when talking about rear-ventilated façades. But by using prefabricated systems it is possible to find a solution with the same system used for the entire envelope.

➔ Main issue is to check whether weak points can be eliminated by a renovation. If not it is possible to arrange compensation measures to avoid further negative implications.

#### 3.2.1. Modifications of window-sizes

To find the balance between optimized daylight within rooms and prevent overheating caused by too large glazing is very difficult. Asking occupants of existing buildings if there is a current overheating situation in summer will result in a variety of individual perceptions. To get objectively correct statements detailed measurements of room and surface temperatures are necessary – but very rarely possible before renovation.

Generally north-oriented windows and glazings should be smaller to reduce losses during winter and all south-/ south-west-oriented windows and glazings should be larger to optimize solar gains. Empirical

<sup>21</sup> "PHPP 2007" is the 7th revised edition of the "Passive House Planning Package". The PHPP 2007 is a design tool, which can be used by architects and designers to calculate the energy balance of buildings with very low energy consumption [4].

values are collected in Table 9, they are not scientific proven and should only be used for first estimations.

<b>Windows and glazed areas oriented to the south</b>	15-40% of the specific façade area
<b>Windows and glazed areas oriented to the east or the west</b>	10% of the specific façade area
<b>Windows and glazed areas oriented to the north</b>	5% of the specific façade area

*Table 9: Empirical values for windows and glazed areas due to different orientation (without shading systems)*

By using additional shading systems especially south-oriented glazed areas can be enlarged (depending on the kind of system) up to nearly 80%.



*Figure 8: South-west oriented windows – shaded with exterior blinds (Source: Ziv. Ing. Büro Boder)*



*Figure 9: South-east oriented class-room windows – shaded with exterior blinds*

### 3.2.2. Integration of balconies and living space extension

Balconies within buildings from the post-war period or the time of economic boom are typical thermal weak points due to their construction (slabs made of reinforced concrete, reaching out without thermal separation).

Basically there are three possibilities to eliminate them or avoid negative implications:

- Cutting off the slab and erecting a new construction in front of the new envelope (steel or timber construction)
- Insulation of the upper side and lower side of the slab – but a problem may arise concerning the height difference between upper edge of floor and balcony (using vacuum insulation can minimize this problem)
- Integration of the balcony into the new thermal envelope – to reach enhanced living space



Figure 10: Balconies before renovation within residential area Dieselweg, Graz



Figure 11: Integrated balconies after renovation within residential area Dieselweg, Graz

### 3.2.3. Access (barrier-free and escape-routes)

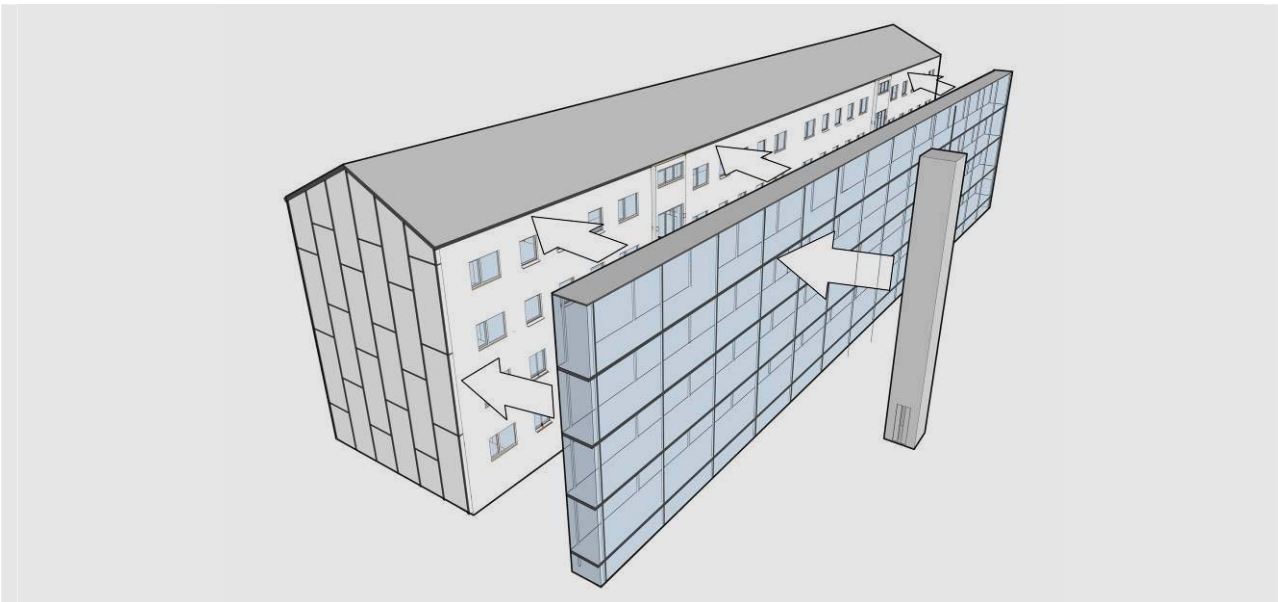

Figure 12: New access systems for existing buildings as an example: Arcades and new passenger elevator (Source: Weiss Tobias – Nussmüller Architekten, Graz)

A barrier-free access is mandatory (even in most of the building codes) and should be an integrative part of every renovation concept. The integration of a passenger elevator is easy, but experiences so far show that many residential buildings of the building period 1945-80 have a mezzanine, that is a ground floor which can only be reached by at least one flight of stairs. So the intermediate landing of the staircase is oriented to the outside and any passenger elevator positioned on the outside is only able to serve the intermediate landing and not the actual floor level. If there is no place left on one side of the staircase a possible alternative is to redevelop the entire access system and build a new arcade in front of the existing façade.

Substantial measures can also be requested by inadequate escape-routes. The development of requirements within building codes or standards in the past years shows a need for wider corridors or larger staircases and door openings. It is a crucial and challenging demand – sometimes it can only be solved in a way like mentioned above, namely to redevelop the entire system of access.

Renovation concepts based on prefabricated systems are more flexible to meet requirements concerning extension-buildings – it can be solved in the same way with prefabricated modules brought on-site and assembled.

### 3.2.4. Loft conversion or extension

Unoccupied lofts bear a great potential to contribute to the enlargement of high-quality living-space on locations with optimized infrastructure and living quality. Especially locations near city-centres often need more space as offered. Beside economic reasons post-compaction is a very good instrument to contribute to ecological aspects of city-development. Better exploitation of existing infrastructure, no additional use of building land and reduced lines of communication are some of the advantages.

But unimpeded loft extension is restricted by the introduction of the “Eurocode 8” [5] – an European standard which has an influence on security measures within buildings due to earth-quake risks. With reference to this Eurocode it is necessary that even old buildings have to fulfill requirements like new buildings.

Every country has the possibility within national annexes to define regions due to their earthquake-risk, but as an example: Buildings in Vienna have to resist an earthquake up to 6.2 according to the Richter-scale [6].

### 3.3. Occupancy during construction works

Relocation of occupants is a very sensitive issue. Social conflicts may arise, especially if the age structure of the inhabitants is dominated by elderly people who have been living for a very long time in the same apartment. Not only the interference within their familiar surrounding, but also the uncertainty of coming back or getting new neighbours could be a problem. So a very important question is whether the renovation concept will make it necessary to implement construction works within apartments or not. If there are substantial alterations – like a complete new layout of the apartment – the first choice should be to consider a solution on-site. Maybe there are unoccupied apartments left and can be used to relocated tenants for a while but within the building. Only if there is no alternative a resettlement to a different location should be considered.

If the layout of the apartments is not to be modified and there are only renewals of sanitary equipment or building services it is often possible to install an intermediate bath or toilet, which can be used in the meantime. The key issue is a transparent and comprehensive communication policy with the tenants and a smart and tough reaction on claims concerning trouble.

The chosen renovation concept contributes to this policy. Every concept that depends mainly on on-site and manual workmanship like an external thermal insulation composite system and every small-scaled façade system needs more and longer effort on-site and the surrounding is mostly filled up with priming material, clippings of insulation boards, foils, claddings. Moreover the procedure of sealing windows and doors with plastic foil to protect them during work has a great influence on occupied apartments behind. Additionally a lot of safety regulations should be considered to secure the safety and health of occupants during construction works. For example: in Austria it is forbidden for unauthorized persons to enter a construction-site. So it needs a careful planning of the construction procedure to separate occupied areas from zones with construction works.

The longer the renovation lasts, the more challenging is the task to guarantee safety for both – workers and occupants. Assembling large-scaled prefabricated elements may afford extended safety regulations during assembling – but is for a shorter time-span. It should be considered whether a scaffold for a longer time span in front of the façade which influences the safety of tenants (accessibility to every window) is better than a transport of large-scaled elements with low-loaders and additional mobile-cranes.

Furthermore the formation of dust and noise may influence the health of tenants. Some works will cause more dust and noise than others. Works causing a lot of dust should be observed by a hygienic monitoring, which can be done by hygienists. Contaminations by dust or harmful particles can be stated or documented – subsequent claims can be prevented.

➡ Main issue is to identify possible critical overlaps in a very early stage to enable a comprehensive information policy towards occupants.

### 3.4. Cleaning and maintenance

Routinely cleaning and maintenance of façades has necessarily established during operation of buildings and causes expenditure and therefore costs – depending on location, accessibility and type of the façade system. Whereas the surface needs mainly cleaning, all moveable parts (fittings and shading systems) have to be inspected periodically (depending on the intensity of utilization it may vary from 2 years to twice a year). The inspection of silicone sealings is often forgotten – but they are important for durable waterproofing.

The decision of the final surface material of the façade shapes the building’s appearance and the following effort of maintenance and cleaning. Several different materials require more or less cleaning to keep a façade visually clean. For example: the surface of walls covered with composite heat insulation systems have lower maintenance costs, but if they are polluted it is more difficult to clean them. Every plastering is sensitive to pressure cleaning if it is applied very often. Plain surfaces – especially glass – cause higher maintenance costs to keep them visually clean. But the surface is more resistant against periodical regular clean. Therefore plain and less structured façade-surfaces are more suitable for locations higher affected by pollution or dust.

➔ Main issue is to identify the implications for subsequent facility management caused by design and definition of a new façade system.

### 3.5. Feasibility check

	 <b>ETICS</b>	 <b>Rear ventilated façade system</b>	 <b>Façade system – partly prefab</b>	 <b>Prefab module system</b>
<b>Construction time</b>	Long construction time-span and time for desiccation	Long construction time-span	Shorter construction time, note manual bringing of insulation	Very short construction time-span on-site
<b>Application within high-performance renovations</b>	Limited thickness concerning freezing condensate on surface	Possible	Possible	Possible
<b>Potential of alteration and optimisation</b>	Yes, but not system-integrated	Yes, but not system-integrated	Realization system-integrated	Realization system-integrated
<b>Occupancy during renovation works</b>	Vast restrictions and discomfort for occupancy	Restrictions concerning long time span	Shorter construction time with minimized influences for occupancy	Very short construction time and minimized restrictions and discomfort for occupancy
<b>Cleaning and maintenance</b>	Long cleaning intervals, but not resistant due frequent cleaning	Plane surfaces can and have to be cleaned	Plane surfaces can and have to be cleaned	Plane surfaces can and have to be cleaned

Table 10: Practical implications of façade renovation systems



## 4. Fire prevention

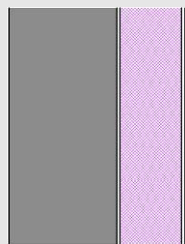
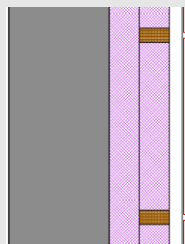
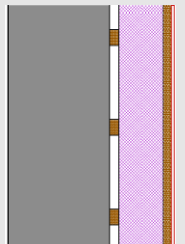
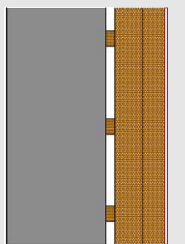
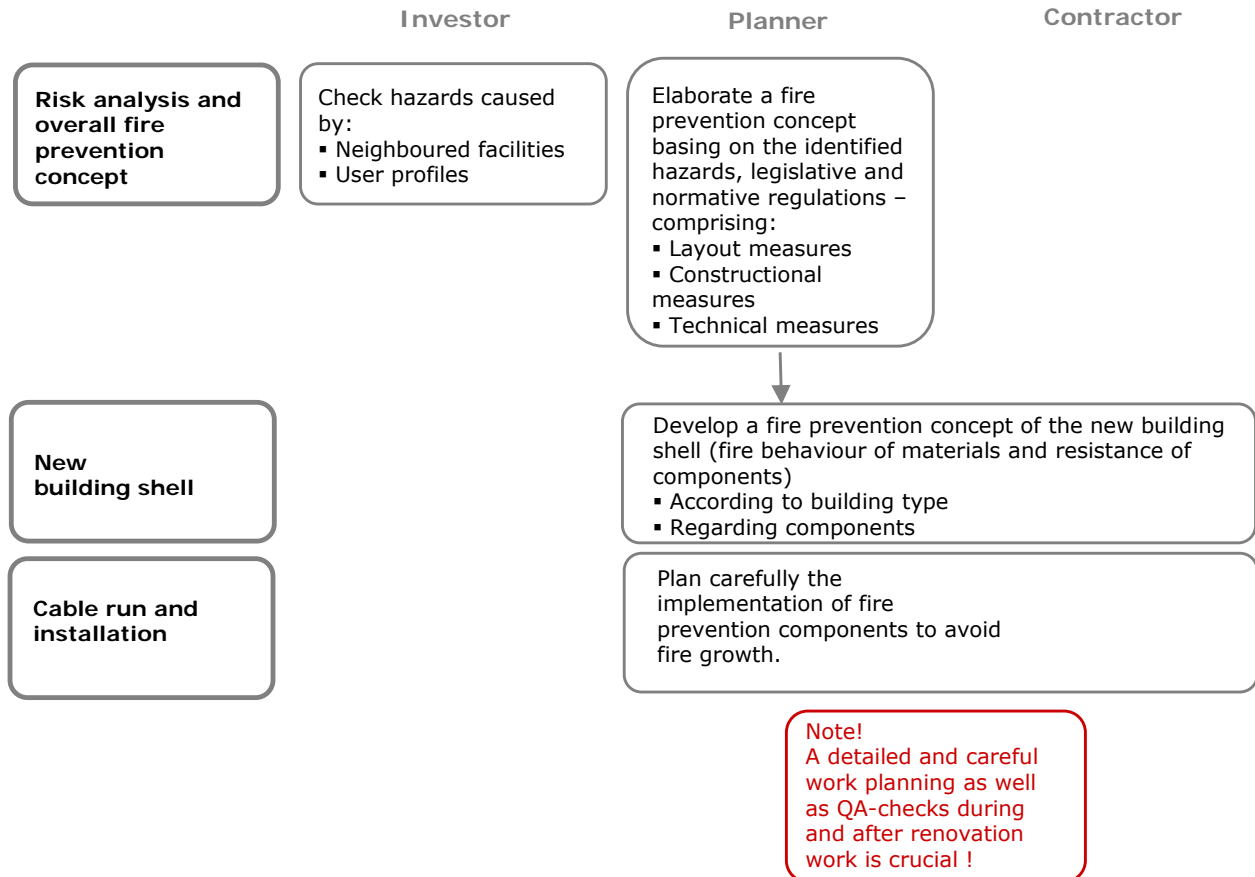

### 4.1. Risk analysis and overall fire prevention concept

Based on a risk-analysis, which comprises risks caused by neighbored buildings or utilizations and risks caused from own usages, an overall concept for fire prevention has to be developed, which should include all necessary fire prevention measures as well as their interactions and their contribution to reach the protective goals. For example in Austria the technical guideline of fire prevention “TRVB A107” defines the evaluation of risks “considering the usage, the risk of fire and the expected extend of damages” [7].

With reference to the complexity of fire prevention only aspects for façade-systems should be presented hereby:

- Hazard of fire-growth and smoke spreading along façade modules
- Hazard of fire-growth and smoke spreading caused by installations, ducts and resulting penetrations of fire-sections

A fire may arise inside an apartment or in the space between existing old and new façade or within integrated installation shafts.

Measures within the overall concept can be

- Measures concerning the layout of building
- Constructional measures (physical structure, materials,..)
- Technical measures (fire detection systems, sprinkler systems, fire dampers, claps,...)

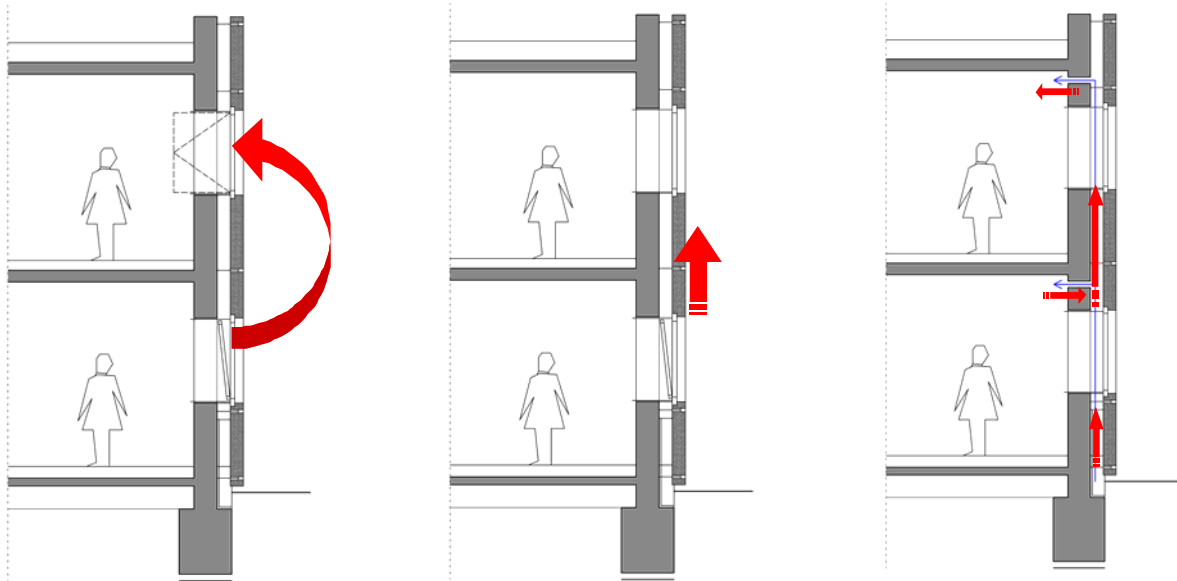

Figure 13: Fire spreading from apartment to the upper one over windows

Figure 14: Fire growth along façade module

Figure 15: Fire spreading within installation shafts or space between old and new façade

Due to the fact that fire prevention is only partly regulated comprehensively in European standards and depends largely on national legal regulations and technical guidelines it seems useful to give an overview on potential risks and possible measures, but the measures required in detail have to be adapted according to national and regional regulations and standards.

➔ Main issue is to identify potential risks.

## 4.2. Fire prevention of the new building shell

Key issue is to evaluate risks which can be caused by façade systems due to fire growth or smoke spreading within the façade system and air-spaces (ventilated or not ventilated). Fire prevention measures concerning the new building shell will be influenced by the:

- Fire behaviour of the chosen materials
- Fire resistance of the applied components
- Way of construction of the new façade system

### 4.2.1. Fire behaviour of implemented material

A façade covers the outside of building and connects apartments vertically which are mostly divided into different fire-sections. Furthermore in case of fire the growth proceeds along façades vertically – from bottom to top. Therefore it is essential that this proceeding is not enhanced by the materials and the structure of the new façade system. Requirements on fire behaviour properties of different materials are stated in European standards and have to be executed by national building codes and regulations.

In Austria the legal document of the *OIB*-guideline no. 2<sup>22</sup> relegates to the ÖNorm B 3806.

<sup>22</sup> *OIB*-guidelines are published by the Austrian Institute of Construction Engineering (*OIB*) [www.oib.or.at](http://www.oib.or.at) – They are representing the technical part of the Austrian building codes and are valid for all 9 federal provinces.

<b>ÖNorm EN 13501-1</b>	Fire classification of construction products and building elements - Part 1: Classification using data from reaction to fire tests
<b>ÖNorm B 3806:2005</b>	Requirements for fire behaviour of building products

Table 11: Relevant standards concerning fire behaviour in Austria

The ÖNorm B 3806 regulates systems and products, classified according to the ÖNorm EN 13501-1, due to their application. The classification of building classes is now co-ordinated and segmented into 5 classes (GK 1-5) depending on the extension of gross floor area, number of floors and units.

Concerning composite heat insulations systems the fire behaviour and additional measures like positioning of fire-breaks or insulation of soffits can be found within this standard as well as in processing guidelines of the manufacturers. (→ [www.wärmeschutz.at](http://www.wärmeschutz.at))

Within curtain walls or rear ventilated systems all structural components have to be considered:

- Sub-structures
- Joint and fixing elements
- Insulation layers
- Ventilated or non-ventilated airspaces
- Claddings

Therefore the fire behaviour of every material has to fulfil the requirements caused by the component and influenced by the building classification.

Every new façade in front of the existing wall will support fire growth if it is made of combustible components. Therefore, materials – which are ecologically recommendable like wood – have reduced application possibilities. But many of national codes and standards imply exceptions for the use of timber constructions. Some detailed information on the fire behaviour of wood and wood-based materials can be found within the report published by M. Teibinger (*Holzforschung Austria*) [8]: [www.holzforschung.at/fileadmin/Content-Pool/PDFs/Brandverhalten.pdf](http://www.holzforschung.at/fileadmin/Content-Pool/PDFs/Brandverhalten.pdf)

#### Fire resistance of components

The fire resistance is a property of components concerning stability against collapse of walls or potential stiffening components – most of the requirements are regulated by different national building codes. The classification of products is regulated by a European standard. Ten years (beginning 2000) were foreseen as coexisting period of national and European standards. Since May 03, 2010 only products certified according to European standards are allowed to be used.

<i>EN 13501-2</i>	Fire classification of construction products and building elements - Part 2: Classification using data from fire resistance tests, excluding ventilation services
-------------------	---

Table 12: Relevant standards for fire classification

#### 4.2.2. Spreading of fire and fume between existing walls and new façade systems

A series of measures can avoid spreading of fire and fume – the detailed requirements have to be adapted according to national regulations and standards. The following overview shows different hazards that have to be considered.

**Hazard of flash-over within different fire-sections**

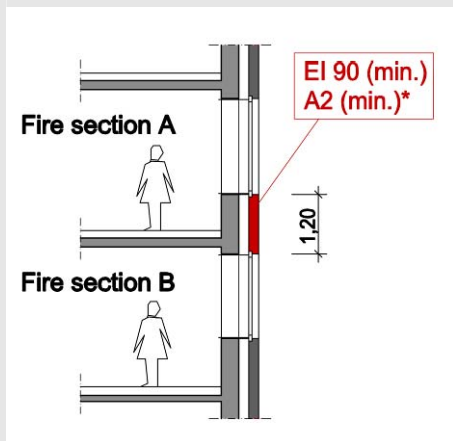

Possibility to avoid flash over  
(Source: OIB-guideline no.6, 3.1.5)

\* Building class 5 or higher

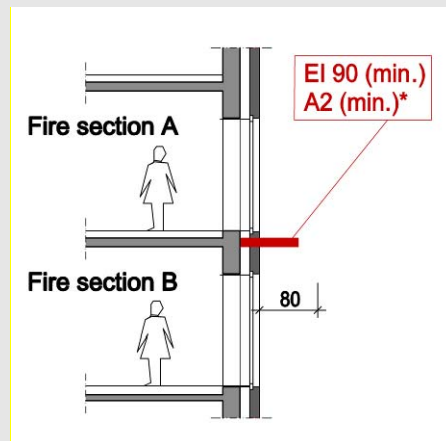

Possibility to avoid flash over  
(Source: OIB-guideline no.6, 3.1.5)

\* Building class 5 or higher

**Hazard of flash-over for all buildings of building class 5 and more than 6 levels**

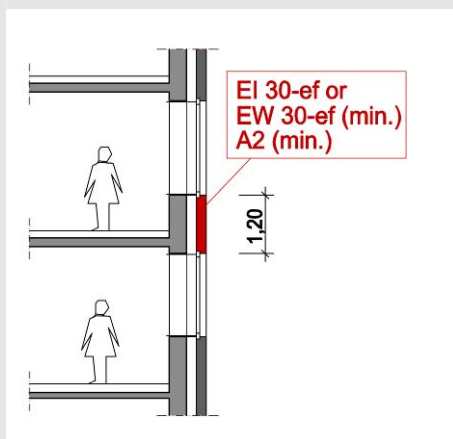

Possibility to avoid flash over  
(Source: OIB-guideline no.6, 3.3)

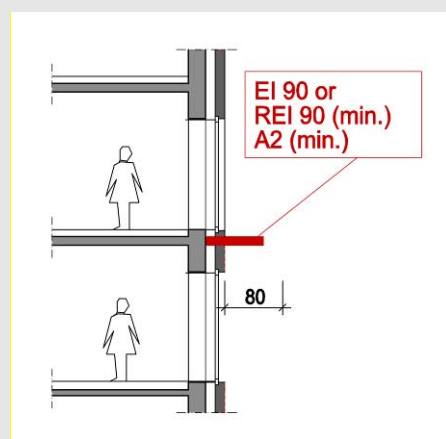

Possibility to avoid flash over  
(Source: OIB-guideline no.6, 3.3)

**Hazard of fire growth within intermediate space**

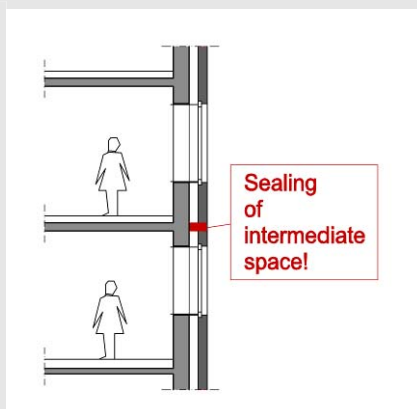

Façade modules rear-ventilated:  
In order to avoid fire growth within intermediate space – sealing necessary!  
(Source: OIB-guideline no.6, 3.5.1)

Table 13: Overview on different hazards of fire spreading and possible measures

➔ Main issue is to identify critical points and to show a path to prevention measures.

### 4.3. Cable run and installation

A new and innovative possibility within renovation uses the new façade system to integrate vertically oriented installation ducts and horizontally oriented installation conduits. Old piping and installation lines can be renewed or new units can be installed without substantial works within the apartments. The main supply line runs in front of the old façade, but any supplied apartment needs a breakthrough to get junction to the main supply lines. Typically each apartment is one separate fire-section (depending on national regulations) but the space between old and new façade is not separated according to the apartments behind. Therefore two main fire risks have to be noted:

- Risk of fire originating within a duct or conduit and infiltration into apartment
- Risk of fire emerging in an apartment, infiltration into duct and transferred to further apartments

A fire originating in a duct or conduit may be caused by power supplied wiring or units or hot works within piping or installation network. From experience – a fire once emerged will spread rapidly within the ducts causing further hot smoke.

Fire emerging in apartments can spread via the installation lines into the ducts – the proceeding is the same as mentioned before. In both cases ventilation systems bear a great risk of a very quick transfer through all over the building within different sections – if there is no separation.

Not only conduction along the piping but also the penetration of walls and slabs has to be considered. Basically at every penetration of a component separating different fire-sections adequate compartment measures (fire-bulkheads) have to be implemented. But only systems with a classification due to European standards and tested by accredited testing institutes may be used.

Depending on the manufacturer there are a lot of possibilities to separate piping, wiring or ducts when passing different fire-sections. The necessary measure depends on:

- Type of installation (water-/air conducting pipes and ducts, electric wiring, gas conducting pipes)
- Diameter or cross-section of pipe or duct
- Number of pipes and ducts (cable trays, different installations running together)
- Component which is penetrated

There is a great selection of products, detailed information on different products and measures can be found in product catalogues and guidelines from different manufacturers (exemplary):

[www.hilti.at](http://www.hilti.at); [www.wuerth.at](http://www.wuerth.at);

[www.geberit.de/web/app/de/CMSKatalogde.nsf/pages/DerGeberit-Brandschutzloesungen-1](http://www.geberit.de/web/app/de/CMSKatalogde.nsf/pages/DerGeberit-Brandschutzloesungen-1)

➡ Main issue is to identify critical points and show a path to prevention measures.

#### 4.4. Feasibility check

				
	<b>ETICS</b>	<b>Rear ventilated façade system</b>	<b>Façade system – partly prefab</b>	<b>Prefab module system</b>
<b>Fire behaviour</b>	Utilization of classified systems	Fire behaviour of each component has to be considered.	Fire behaviour of each component has to be considered.	Fire behaviour of each component has to be considered.
<b>Fire resistance</b>	Stability has to be ensured by underground (existing wall).	Stability has to be ensured by underground (existing wall).	Fire resistance of load bearing structural components have to be considered.	Fire resistance of load bearing structural components have to be considered.
<b>Fire growth within façade area</b>	Fire breaks within window-lintel; distance between window lintel and parapet to avoid flash-over;	Measures preventing growth within intermediate spaces; distance between window lintel and parapet to avoid flash-over;	Measures preventing growth within intermediate spaces; distance between window lintel and parapet to avoid flash-over;	Measures preventing growth within intermediate spaces; distance between window lintel and parapet to avoid flash-over;
<b>Fire growth along pipe / cable running within façade integrated installation ducts</b>	No risk if there are no installations	No risk if there are no installations	No risk if there are no installations	In case of integrated shafts provide measures to prevent fire growth.

Table 14: Fire issues related to façade renovation systems

## 5. Sound insulation



### 5.1. Requirements

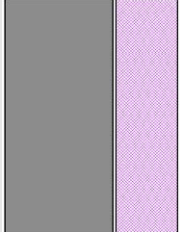
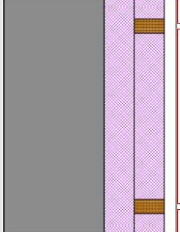
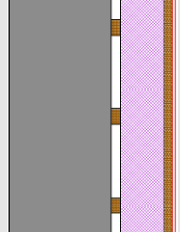
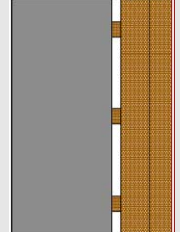
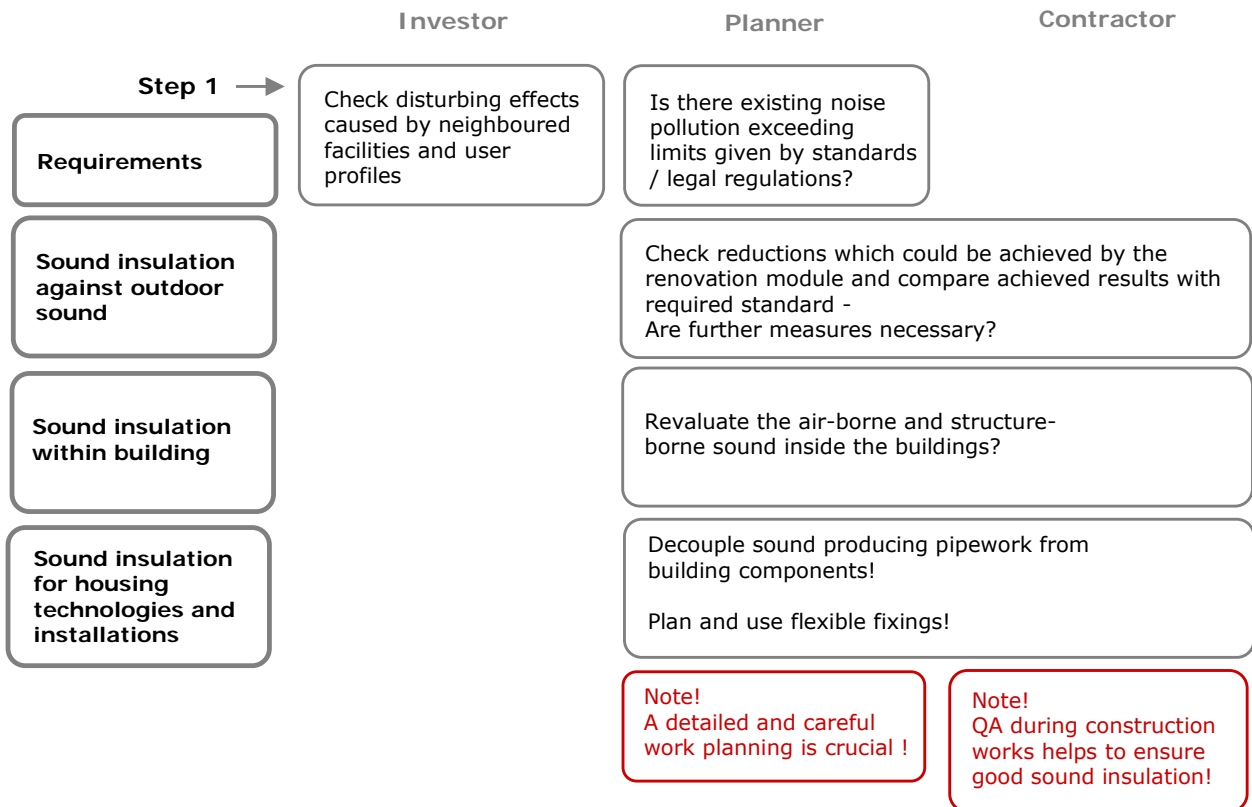

Figure 16: Air-borne sound from outdoor

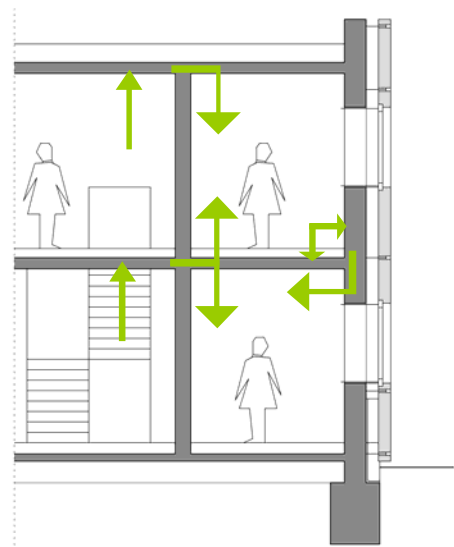

Figure 17: Air-borne or structure-borne sound between different apartments or public spaces and apartments

A sound insulation supports the protection of living and adjoining rooms from sound emissions, which may perform as:

- Air-borne sound from outdoor (emerging from traffic or surrounding facilities)
- Air-borne sound between different apartments or public spaces (corridors, staircases) and the apartment
- Structure-borne sound between different apartments or public spaces (corridors, staircases) and the apartment

Following standards provide definitions and requirements concerning sound insulation:

<b>ÖNorm EN 12354 Part 3</b>	Building acoustics - Estimation of acoustic performance of buildings from the performance of elements - Part 3: Airborne sound insulation against outdoor sound
<b>ÖNorm B 8115 Part 1, Part 2, Part 4</b>	Sound insulation and room acoustics in building construction Part 1 – Concepts and units Part 2: Requirements for sound insulation Part 4: Measures to fulfil the requirements on sound insulation
<b>DIN 4109</b>	Sound insulation in buildings
<b>SIA 181</b>	Sound insulation in buildings

Table 15: Extract of relevant standards concerning sound insulation

➔ Main issue is to identify appropriate requirements defined by standards to ensure sufficient prevention.

## 5.2. Sound insulation against outdoor sound

First all potential disturbing noises have to be identified within the investigation of the surroundings (see 1.1). Depending on the surrounding infrastructure and neighbored facilities a lower or higher continuous sound level has to be expected. With reference to possible neighbored nuisance emissions, which exceed customary in place emissions, it might be necessary to assess the actual continuous sound level on-site. Afterwards a comparison of the existing situation with legal requirements or recommendations of standards will show the range of necessary sound insulation measures.

Sound is spreading by the variation of air pressure, which are detected by the human ear and transferred to the brain. The reduction of the sound (sound-level difference) is called sound reduction index. The lower you hear the sound inside an apartment the better the sound reduction index from outdoor or the neighbouring room. Therefore this index states the amount of sound which passes a component due to the original sound. For example: a sound reduction index of 10 dB states that 1/10 of the original sound may pass. The higher the index the better the sound reduction potential of a component.

A very common conclusion is to assume, that improved heat insulation leads to improved sound insulation in any case. The sound reduction index of monolithic walls or single shells is determined by the area weight of a component. How does the transmission of sound within monolithic walls happen? Stimulated by the variations of air pressure the wall gets into vibration and acts like a sound box – the air behind it is put into oscillation as well. Therefore the sound reduction is getting better if the component has a high area weight. Within old buildings most of the walls are built of monolithic walls – made of brick or concrete and are therefore very heavy.

High area weight is contradictory to insulation layers. A very common method within renovation is to bring up an external thermal insulation composite system. But in early stages of development of these insulation systems, these measures degraded the sound reduction in some cases. The reason was the very thin, but stiff layer of insulation (mostly polystyrene) together with a probably "light" existing wall behind led to contra-productive effects for the sound reduction.



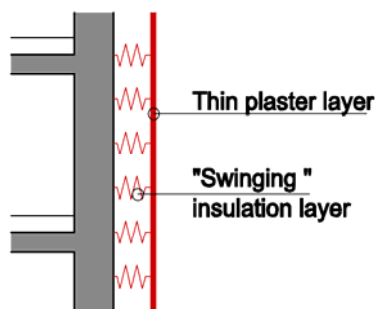

Figure 18: External thermal insulation composite system acting as a swinging layer and influencing sound transmission

But nowadays the use of mineral wool and thicker layers of insulation (see Figure 18) contribute to an improved sound reduction of the wall-system.

Referring to the way of transmission it is obvious that leakiness and cracks contribute to sound transmission between different parts – the oscillating air spreads within every gap.

Following measures contribute to improved sound insulation against air-borne sound:

- Massive and heavy components – the higher the area weight the better the reduction potential
- Improvement of air tightness – between different units and to the outside
- New windows

Generally spoken it is necessary to evaluate the entire system (wall with integrated windows and junctions) and due to mostly massive walls the biggest contribution to improved sound reduction is the exchange of windows and their airtight integration into the wall-system.

Requirements for sound reduction of different components are given by the above mentioned standards or legal regulations (both depending on the country) and due to the actual outdoor sound level.

➔ Main issue is to evaluate the sound reduction index achieved by the new façade and identify whether it is sufficient enough or further measures are necessary.

### 5.3. Sound insulation within the building

Sound insulation within the building concerns

- Air-borne sound
- Structure-borne sound

Basic information on air-borne sound transmission is given in the chapter before. But within renovation a new aspect has to be considered for sound insulation inside buildings (between apartments or apartments neighboured to public rooms, corridors and staircases).

Structure-borne sound is transmitted within the building by transmission within flanking components ("flank transmission"). The vibration (for example from impact sound) is transmitted along the component and stimulates oscillation of adjacent air layers. A very efficient sound insulation measure is to reduce or eliminate transmission paths by flexible bearing or decoupling of components.

New systems mounted on the outside of the façade may generate new transmission paths (flank transmission). It is essential to avoid this by careful planning of fixing and assembling.

While covering the building with a new envelope on the outside the existing sound reduction against outside is improved. Less disturbing sound intrudes from outside into the living space. But now every sound coming from neighbouring units is dominating – even if the level is the same as before.

**Note!**

If the building gets a new shell, which improves significantly the sound reduction index it is recommended to re-evaluate the sound reduction index inside the building – among different apartments as well as between apartment and public spaces.

➔ Main issue is to re-evaluate the existing sound insulation inside the building and find appropriate measures.

**5.4. Sound insulation for housing technologies and installations**

Until now it was a common practice to have installations within the building shell. It was more difficult to reduce sound emerging from water-conducting pipes, sewage pipes or toilet flushing – but careful planning and implementation was and is state of the art.

By having new shafts on the outside – the sound is now coming from a different direction. Every water-conducting pipe or sewage pipe is separated by the (mostly) massive exterior wall from the living space inside. So the heavy area weight of these walls will contribute to sound reduction. Some of the sources of noise will remain inside – a lot of common sound insulation measures can be applied to avoid disturbances. But it is new to have the option to install ventilation devices within the new façade system. It is new to have installations and pipes on the outside. So there is a new sound disturbance coming from the outside. The crucial issue is to take care of flexible fixing and decoupling of pipe work or devices which may cause vibrations or sound.

Furthermore it is crucial how ventilation ducts or water-conducting pipes are passing the wall to the inside.

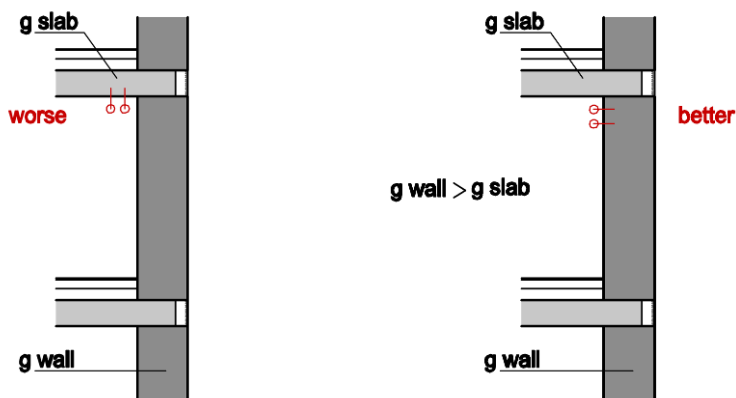

Figure 19: Piping inside apartments – mounted on the component with heavier area weight

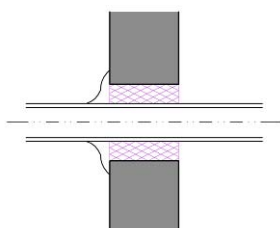

Figure 20: Pipe passing from installation duct into apartment

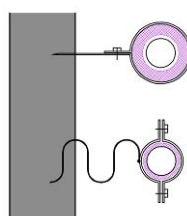

Figure 21: Fixing pipes to avoid sound transmission

➔ Main issue is to identify critical points within building services and set measures for prevention.

## 5.5. Feasibility check

				
	<b>ETICS</b>	<b>Rear ventilated façade system</b>	<b>Façade system – partly prefab</b>	<b>Prefab module system</b>
<b>Sound insulation against outdoor sound</b>	Usage of correct insulation material, adequate thickness of insulation layer and priming / plastering	Systems with large area-weight may improve sound insulation significantly.	Systems with large area-weight may improve sound insulation significantly.	Systems with large area-weight may improve sound insulation significantly.
<b>Sound insulation within the building</b>	No implications	If significant reduction against outdoor sound – reevaluation of sound insulation inside necessary.	If significant reduction against outdoor sound – reevaluation of sound insulation inside necessary.	If significant reduction against outdoor sound – reevaluation of sound insulation inside necessary.
<b>Transmission of structure-borne sound</b>	No implications	Flexible bearing and fixing, consequently decoupling.	Flexible bearing and fixing, consequently decoupling.	Flexible bearing and fixing, consequently decoupling.
<b>Sound insulation against sound emerging from installations.</b>	Common measures within existing or new installations inside the building.	Common measures within existing or new installations inside the building.	Common measures within existing or new installations inside the building.	New installation shafts or units on the outside contribute to reduced disturbing sound.

Table 16: Sound insulation of façade renovation systems

## 6. Building physics and ecology

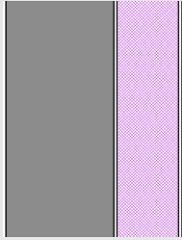
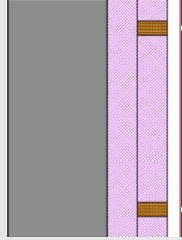
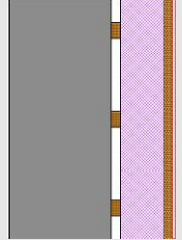
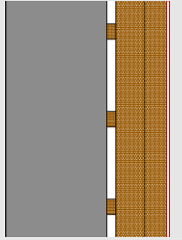
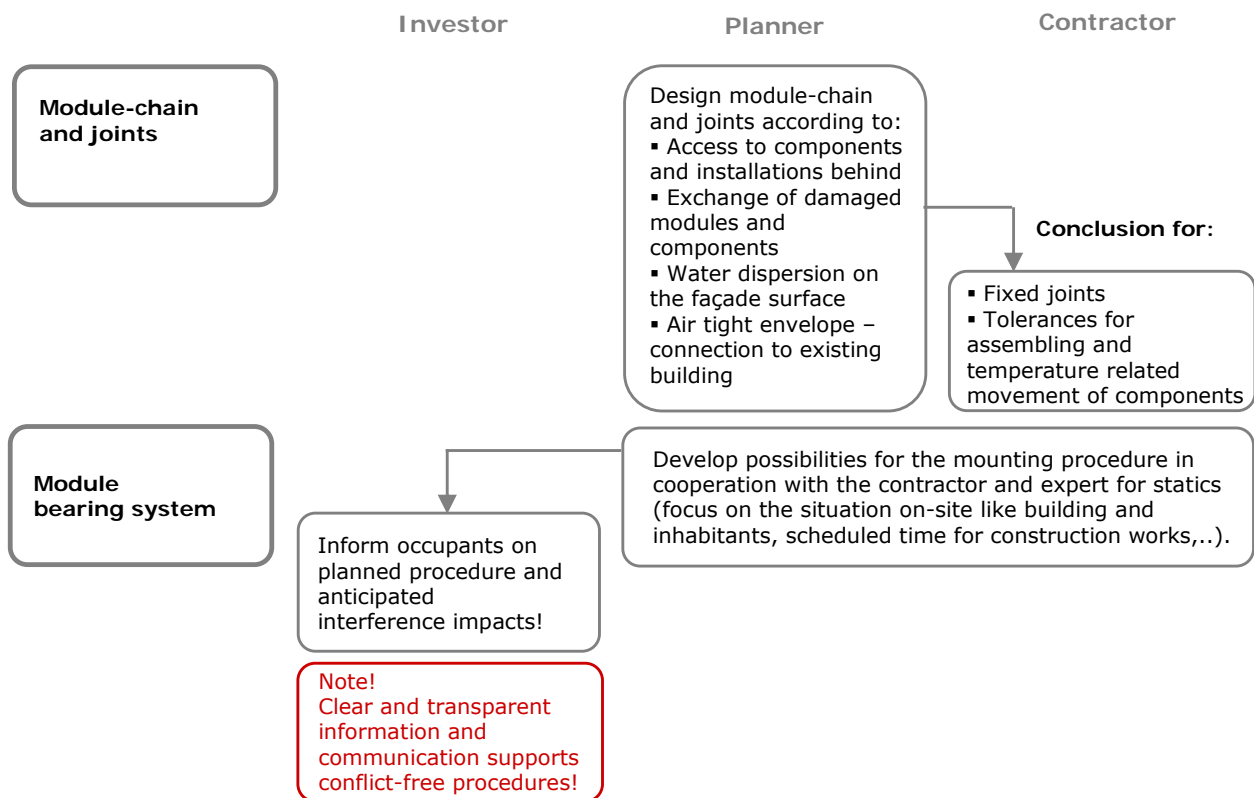

One aspect within chapter 3 was to define the level of renovation standard – a key aspect for further planning - influencing among others the new thermal envelope. The chosen insulation material, layer composition and thickness of each layer determine the thermal performance (U-value), moisture properties and impact on the environment.

Concerning the new envelope high performance renovation requires some key aspects like good thermal behaviour (U-value), consequent elimination of all thermal bridges to avoid condensate, prevention of moisture within structural units, shape of air tight envelope and usage of materials of high ecological quality. High performance renovation is also more demanding in terms of construction quality – therefore a more careful and detailed (working) planning is necessary. Finally every system (manually, prefabricated,...) has to be evaluated referring to the framework given by the existing building. Technically correct systems may not be suitable in any case.

### 6.1. Thermal quality

Thermal quality contributes to reduced heat transmission losses, to higher internal surface temperatures and therefore to improved user comfort. Generally thicker layers of insulation result in improved U-values. Sometimes during renovation it may be difficult or impossible to enlarge outer dimension of a building (see 1.2), insulation materials of higher quality may contribute to thinner layers, but the resulting difference is rarely essential.

Insulation material	Thermal conductivity W/(m·K)
Cork	0.045
Mineral wool	(0.035-) 0.040
Foam glass	0.045
Extruded polystyrene	0.035

Table 17: Overview thermal conductivity of different insulation materials

A possible alternative are vacuum insulation panels (VIP) but they are more expensive and demanding in planning and within completion. So they are suitable for very specific fields of application (if the thickness is a key issue like on doors to flat-roofs).

As mentioned before the renovation standard determines the thermal quality of the envelope. Table 18 shows exemplary values required by different standards. The Austrian building code depicted in the "OIB guideline no. 6" is not very ambitious – every "standard renovation" should meet these requirements. Even if there is no common understanding on the specific key figures for low-energy houses the values are more demanding, while passive house standard within renovation is – depending on the initial situation – an ambitious goal.

Construction unit	OIB-guideline no. 623 W/(m <sup>2</sup> ·K)	Low-energy houses W/(m <sup>2</sup> ·K)	Passive houses [4] W/(m <sup>2</sup> ·K)
Roofs	0.20	0,15 – 0,25	≤ 0.15
Windows	1.40	1.20	≤ 0.80
Outside walls	0.35	0.20 – 0.30	≤ 0.15
Basement ceiling slab	0.40	0.30 – 0.35	≤ 0.15

Table 18: Overview different U-values of relevant building components

Methods for calculation of thermal quality as well as on user's comfort can be found in various European and national standards (see Table 19).

EN ISO 6946	"Building components and building elements- Thermal resistance and thermal transmittance- Calculation method"
ÖNorm EN 15251	"Indoor environmental input parameters for design and assessment of energy performance of buildings addressing indoor air quality, thermal environment, lighting and acoustics"
EN ISO 7730	"Ergonomics of the thermal environment – Analytical determination and interpretation of thermal comfort using calculation of the PMV and PPD indices and local thermal comfort criteria"
DIN 4108-1 to 4, 6, 8, 10 (some pre-standards or drafts)	"Thermal insulation and energy economy in buildings"
VDI 4701 Sheet 1	"Planning and dimensioning of the indoor climate (VDI ventilation code of practice)"

Table 19: Extract national and European standards for thermal insulation requirements

## 6.2. Moisture prevention

The content of water vapour of inside air is considerably higher than the amount in the air outside. If the warm air from inside containing water vapour penetrates into the component and passes several layers to the outside – it will cool down during this process (outside the component the temperature – during cold season – may be at -13°C). Somewhere the air will pass the condensation point – and water will drip out. This leads to moisture development within the component and causes considerable and mostly for a long time undiscovered building damages.

- ➔ Main issue is to avoid moisture development by a careful planning and completion, especially concerning:
- The correct position of vapour barriers or retarders within the layer composition
  - An air tight envelope to prevent exfiltration

<sup>23</sup> OIB-guidelines are published by the Austrian Institute of Construction Engineering (OIB) [www.oib.or.at](http://www.oib.or.at) – They represent the technical part of the Austrian building codes and are valid for all 9 federal provinces.

<b>ÖNorm B 8110-2</b>	“Thermal insulation in building construction – Part 2: Water vapour diffusion and protection against condensation”
<b>DIN 4108-3</b>	“Thermal protection and energy economy in buildings – Part 3: Protection against moisture subject to climate conditions; Requirements and directions for design and construction”
<b>SIA 180; SN 520180</b>	“Heat and moisture protection in building construction”
<b>EN ISO 13788</b>	“Hygrothermal performance of building components and building elements – Internal surface temperature to avoid critical surface humidity and interstitial condensation – Calculation methods”

Table 20: Overview legal and normative regulations for moisture prevention requirements

### 6.3. Airtight envelope

Leakiness within the thermal envelope contributes to thermal losses caused by infiltration as well as condensate development caused by exfiltration. Condensate within a component reduces the performance of insulation layers, which often remains undiscovered and leads to building damages (see 6.2). But furthermore air tightness leads to draughts (by component joints) and decreased sound insulation.

A careful planning considers the air tightness of the entire envelope comprising all joints and critical points. Area sealing as well as linear sealing is by the way a common practice. But especially renovation requires more: in many cases removed internal plaster finishes or unplastered areas cause leakages. Furthermore existing and remaining installations and fittings (like sockets, distribution boxes and panels) or invisible joints like the connection between floating floor screed and the wall or missing links to the stair-flights are weak points in the air tight envelope.

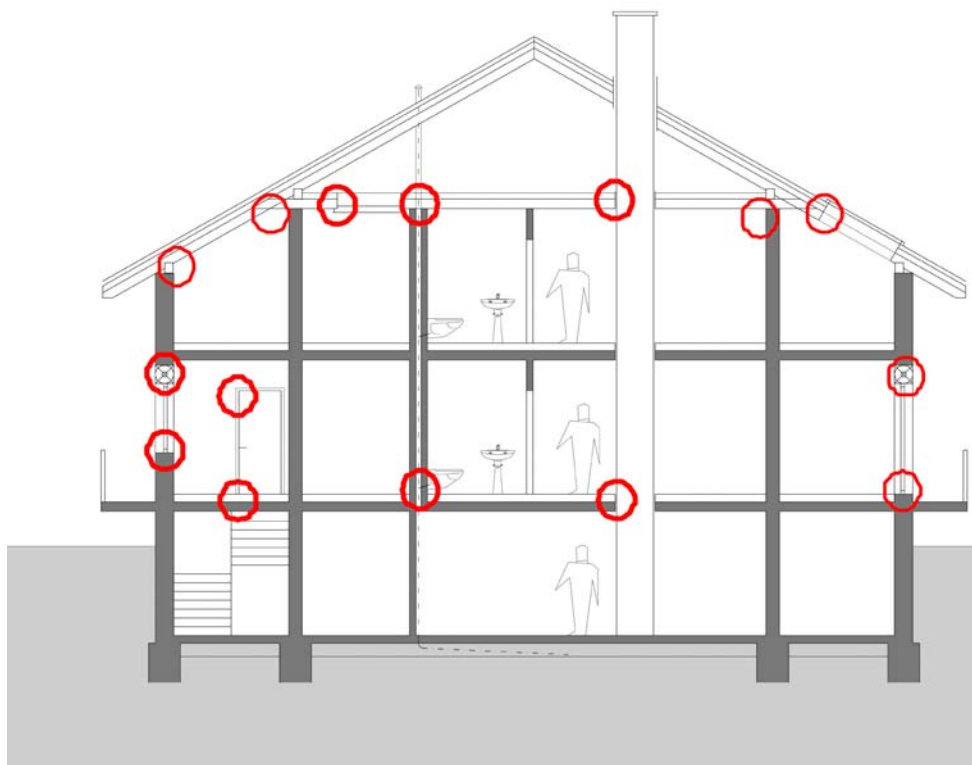

Figure 22: The airtight envelope – critical points

The validation of the air tightness is done by means of the so-called “Blower Door Test” – a procedure according to ÖNorm EN 13829, respectively ISO 9972.

<b>OIB-guideline no. 6 *24</b>	$n_{50} \leq 3.0 \text{ h}^{-1}$ – without mechanical ventilation $n_{50} \leq 1.5 \text{ h}^{-1}$ – with mechanical ventilation
<b>„klima:aktiv-passivhaus“ - Renovation of residential buildings [2]</b>	$n_{50} \leq 1.5 \text{ h}^{-1}$ , additional points if the value $n_{50}$ is $\leq 0.6 \text{ h}^{-1}$

Table 21: Overview leakage rate  $n_{50}$  – Difference of test pressure  $50 \text{ Pa}^{25}$

## 6.4. Ecological assessment

Ecological assessment can be done from two point of views: product-related and object-related. Object-related assessments are furthermore life cycle analysis of buildings (LCA) and are based on declarations of single buildings products.

The initial point therefore is the ecological evaluation of building products and building components. The assessment identifies and assesses criteria, which influence the environment, buildings and occupants. The increasing number of products on the market and more complex constructions make the orientation more difficult.

The assessment is based on: [10]

- Life cycle assessment
- Qualitative criteria
- Eco-labelling
- Environmental declaration

The life cycle assessment is based on quantitative valuation methods. Indicators are (for example) the non-renewable part of primary energy (PEI), the global warming potential (GWP), the acidification potential (AP), and some more [11].

However quantitative criteria do not comprise implications on health during completion or usage or dangerous substances. Therefore qualitative criteria are very important, but it is even more complex to find scientific methods of evaluation [10].

Eco-labelling is used to qualify products. Basic requirements are given by the ISO standard 14024 “Environmental labels and declarations - Type I environmental labelling - Principles and procedures”. But each label comprises very specific qualitative requirements, but they depend on aims and objectives of each label. Within the German-speaking countries the following labels are well known [9]:



[www.natureplus.org/natureplus/](http://www.natureplus.org/natureplus/)  
[www.ibo.at/de/produktpruefung/index.htm](http://www.ibo.at/de/produktpruefung/index.htm)  
[www.umweltzeichen.at/](http://www.umweltzeichen.at/)  
[www.blauer-engel.de/](http://www.blauer-engel.de/)  
[www.eco-label.com/](http://www.eco-label.com/)

<sup>24</sup> OIB guidelines are published by the Austrian Institute of Construction Engineering (OIB) [www.oib.or.at](http://www.oib.or.at) – They represent the technical part of the Austrian building codes and are valid for all 9 federal provinces.

<sup>25</sup> Examples and further detailed information can be found within: IBO – Austrian Institute for Healthy and Ecological Building (Ed.): “Details for Passive Houses - A catalogue of ecologically rated constructions”. Wien 2009 [9]

## 6.5. Feasibility check

				
	<b>ETICS</b>	<b>Rear ventilated façade system</b>	<b>Façade system – partly prefab</b>	<b>Prefab module system</b>
<b>Thermal quality</b>	Depending on thickness. Too thick layers may cause freezing condensate.	Note! Careful planning to avoid thermal bridges emerging from fixing.	Uneven spaces can be insulated easily by blowing insulation into space between old and new façade.	Uneven spaces can be insulated easily by blowing insulation into space between old and new façade.
<b>Moisture properties</b>	No significant implications.	Air ventilation relieves moisture prevention.	Air ventilation relieves moisture prevention.	Note! Careful planning and completion necessary.
<b>Air tightness</b>	Note! Careful planning and completion necessary.	Note! Careful planning and completion necessary.	Note! Careful planning and completion necessary.	Note! Careful planning and completion necessary.
<b>Ecological assessment</b>	Depending on chosen materials. Recycling due to the way of making not really possible at the moment.	Depending on chosen materials. Decomposition potentially facilitates recycling.	Depending on chosen materials. Decomposition potentially facilitates recycling.	Depending on chosen materials. Decomposition potentially facilitates recycling.

Table 22: Implications related to building physics and ecology of façade renovation concepts



## 7. Basic module kit

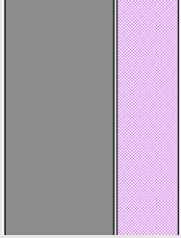
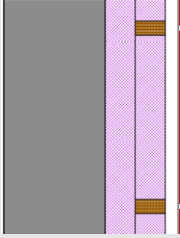
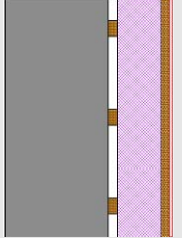
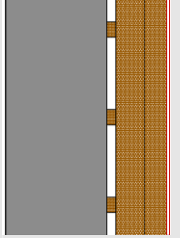
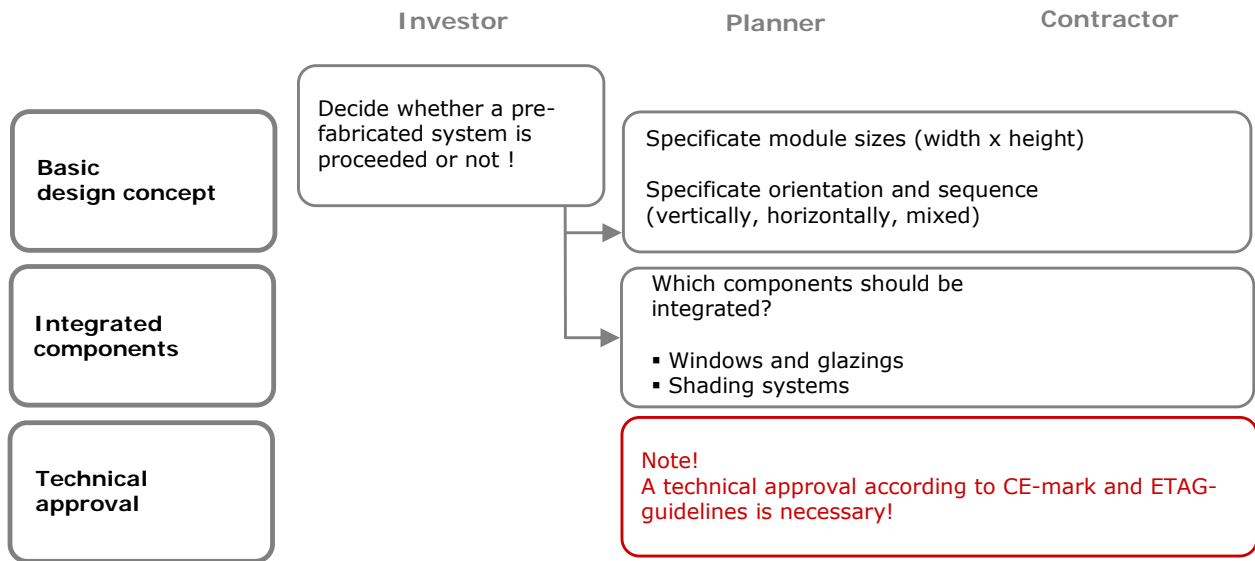

The conception of the basic module-kit determines the future visual identity of the façade – surface, structure, segmentation. But on the way to find the optimized solution a series of technical, logistical and economic parameters have to be considered.

### 7.1. Basic design concept

#### 7.1.1. Specification of module sizes

The specification of maximal possible and minimum sufficient sizes of the basic module is determined by criteria of transport and sizes of available material:

- What are available standardized sizes of necessary boards, sheets or plate material?
- How is it possible to minimize clippings?
- What is the maximum size of a module for transportation?
- What is the maximum size for delivering on-site and lifting to the façade due to the ranges for set-up area and possible lifting auxiliaries?

#### 7.1.2. Specification of module orientation and sequence

The orientation – vertically or horizontally - will be determined by the static system (see 8.1), the load bearing capacity and structure of the existing old wall. Massive wall systems are very flexible as both, vertically and horizontally oriented modules are possible. Skeleton or plate type constructions affect a pattern – load bearing points are fixed and determine the module size.

The orientation will influence further aspects:

- Visual appearance (façade structure dominated by horizontally or vertically lines)
- Assembling procedure
- Integration of installation within new façade system (vertical shafts)

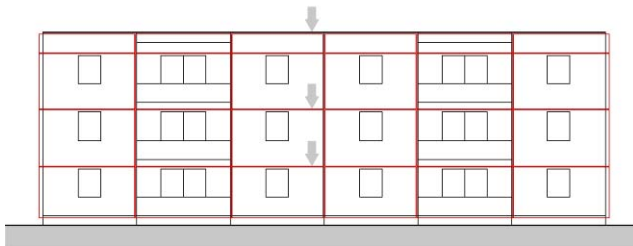

Figure 23: Modules oriented horizontally

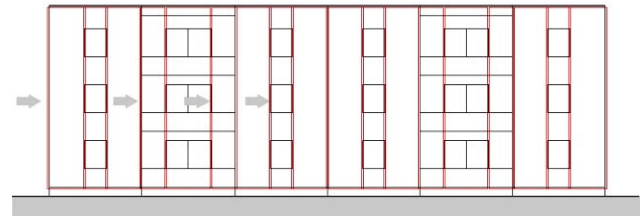

Figure 24: Modules oriented vertically

➔ Main issue is to adjust design and visual appearance with technical and constructive aspects.

## 7.2. Integrated components

Prefabricated modules bear the potential of easy integration of additional components. The basic assembly is done in the fabrication hall under guaranteed conditions. There are a lot of joints and junctions, which have to be completed carefully. Further any expansion or extension (balconies, new arcades, winter gardens,..) can be prefabricated in a system-integrated way. The additional effort is easier to calculate and is not necessarily carried out on-site – as a consequence the construction time on-site is reduced.

### 7.2.1. Windows and glazings

Windows are substantial components within any façade – visually and technically demanding, due to their complexity: The junction between window-frame and wall is decisive for air tightness, subject to thermal bridges and major issue for the design.

Their scope comprises:

- Optimized supply with natural daylight
- Outlook for occupants
- Insight from outside
- Optimisation of solar gaining

But the balance between optimization of glazings between solar gaining and hazard of overheating during summer is difficult (see 3.2.1. and 7.2.2).

Visual appearance is partly shaped by the position of the window within the reveal. A series of pros and cons result from different window-positions.



Figure 25: Windows exterior flush-mounted

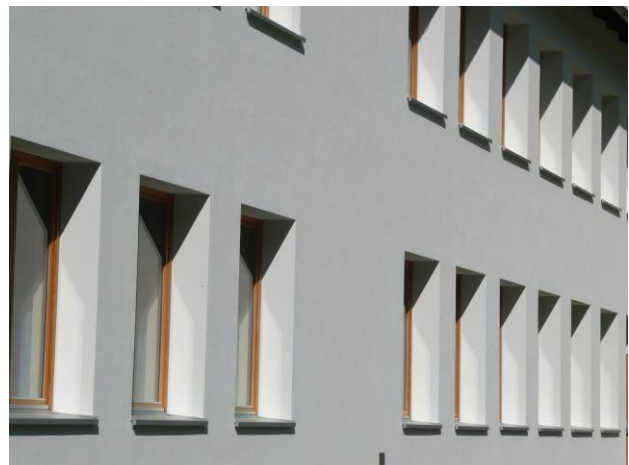

Figure 26: Windows mounted centred within reveal  
(Source: Obereder Hans, A+ ZT GmbH)

	Exterior flush-mounted	Centred in the reveal	Interior flush-mounted
			
<b>Advantages</b>	Simple manufacturing and assembling	Window integrated within insulation level	Optimized position of heat dissipation device (below window) Exterior shadow appliance integrated in lintel
<b>Risks</b>	Potential weak points: Window frame as thermal bridge causing condensate Driving-rain-proof of superior window joint	Air tight connection between window and old façade is hard to implement – potential leakiness	In case of too thin reveal insulation – thermal bridges + heat losses
<b>Precaution</b>	Window position adapted to insulation level – relocation of sufficient distance into reveal to enable insulation-cover of window frame	More carefulness and inspections within completion	Sufficient insulation of reveal at least 3-5 cm.
<b>Dis-advantages</b>	Exterior shadow appliance is difficult to integrate.	Increased effort for working steps and completion	Sufficient insulation of reveal diminishes glazed area for inside of natural daylight

Table 23: Different positions of a window within the reveal

#### Note!

Module-integrated windows provide the advantage of completing the joint between window and new façade under controlled conditions within fabrication hall. Even so the connection between module and reveal has to be completed carefully on-site as well.

➔ Main issue is to adjust overall appearance of the façade with building physical aspects.

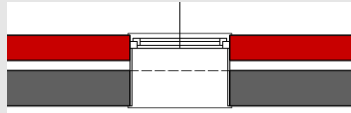
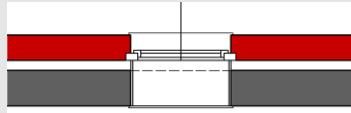
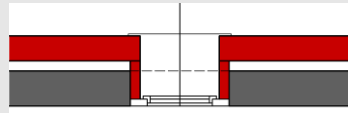
### 7.2.2. Shading systems

Not only heating, but also cooling is getting more and more important for our energy demand. A lot of building regulations and standards in various countries define that within residential buildings active cooling has to be avoided by the careful and intelligent planning of passive measures.

<b>OIB-guideline no. 6 26</b>	7.3 The overheating of buildings during summer has to be avoided. Due to new buildings and comprehensive renovation of residential buildings the Austrian standard „ÖNorm B8110 part 3“ has to be obeyed.
<b>ÖNorm B 8110-3 Thermal protection in building construction - Heat storage and solar impact</b>	6.1 Overheating in summer is regarded as avoided, if the felt room temperature in the specific room during hot seasons does not exceed the limit temperature. The limit temperature is set during operation within daytime at 27°C and 25°C during nighttimes.
<b>DIN 4108-2 Thermal insulation and energy economy in buildings</b>	8.1 Unacceptable temperature conditions within the building construction have to be avoided by means of structural measures and not by elaborative, complex energy-intensive cooling measures.

Table 24: Abstract legal regulations and standards referring to the prevention of overheating

<sup>26</sup> OIB-guidelines are published by the Austrian Institute of Construction Engineering (OIB) [www.oib.or.at](http://www.oib.or.at) – They represent the technical part of the Austrian building codes and are valid for all 9 federal provinces.

De facto even within housing construction overheating occurs, not only in summer but also on days with high irradiation during transitional season.

Key indicators for building's behaviour during summer are:

- Glazing (solar energy transmittance g-value, percentage within façade, orientation, incline)
- Ventilation situation of the room/apartment/building (1-/ 2-/ 3- sided, intensity)
- Location (global radiation)
- Building structure (heat storage capacity, thermal mass, room geometry)
- Sun protection (kind, position, rear ventilated, control)

Most of the indicators can hardly be changed within renovations. Two possible alterations can be mentioned: During construction works inside the building, especially in case of loft conversion the implementation of coverings with heavy area weight or the completion with cement screed instead of dry screed. But the best precaution of overheating is the application of exterior shading systems, especially automatically controlled.



Figure 27: External venetian blinds, upper part adjustable for optimized daylight transport.



Figure 28: External venetian blinds - "all-metal". Very common used within object-range (robustness in case of wind-loads).



Figure 29: Blinds mounted "intermediate" (in-between the glass-panes) – to be used for plane façades.

Overheating precaution measures should be an integrated part of the entire renovation concept and can not be treated separately. The implementation of exterior shading systems is a simple and sustainable measure. Shading systems inside the glazing or in the intermediate space are not as sufficient as outside shading. Highly reflective surfaces of the slats or other measures like intelligent control-systems may contribute to lower cooling demand but the real cause - the transmission of sunlight into thermal energy - is only avoided by external systems.

#### Note!

Manual control of external adjustable shadowing devices is mostly done by crank drives. But the penetration of the crank-drive is on the one hand a thermal bridge and on the other hand a penetration of the air tight envelope. For remedy use an integrated electric motor.

Detailed information for further planning, a lot of possibilities for sun-protection measures can be found within the toolkit of the IEE-project "Keep cool - From cooling to sustainable summer comfort". A lot user-specific information, guidelines and innovative solutions can be downloaded there.

[www.keep-cool.eu/](http://www.keep-cool.eu/)

➔ Main issue is to prevent overheating by passive measures.

### 7.3. Technical approval

In order to put building products on the European market it is necessary to fulfil the Construction Products Directive (89/106/EEG). Aiming on the essential requirements on building structures (security, common welfare, health and environmental protection) mandatory properties of buildings products are regulated. All components or products, which are permanently implemented within buildings have to meet European technical specifications and are identified by the CE-mark. But the CE-mark is only an indicator on the usability. The implementation of this directive is done on national basis – for example in Austria it is anchored in the different building codes of the 9 federal states. The Construction Products Directive shows acc. to Art. 4 par. 2 several kinds of harmonized European technical specifications, which may serve as a basis for CE-marking of building products. One of them is the European Technical Approval (ETA).

<b>ETAG 007</b>	European Technical Approval Guidelines for timber frame building kits (Edition 2001). Identification number of the Austrian version: OIB-467-020/02.
<b>ETAG 017</b>	European Technical Approval Guidelines for venture kits – units for external wall insulation (Edition 2005). Identification number of the Austrian version: OIB-467-031/09.

Table 25: Abstract – European Technical Approval Guidelines (ETAG)

Further information is available within the website of the Austrian Institute of Construction Engineering (OIB): [www.oib.or.at](http://www.oib.or.at)

➡ Main issue is to meet European standards for product classification.

## 8. Joint and fixing techniques

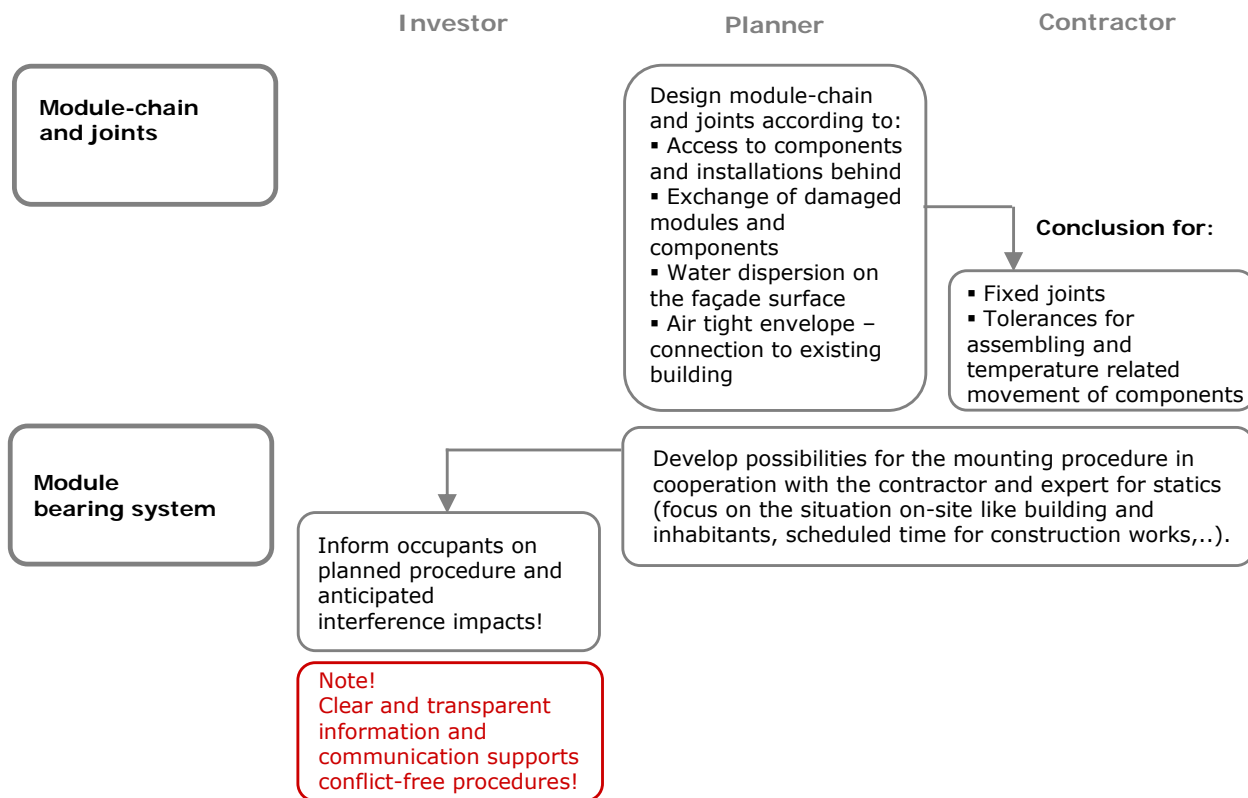

### 8.1. Module-chain and fixing

The design of the module-chain influences first assembly, fixing and joining techniques, but has further implications for maintenance and repair. Interactions are shown in Table 26

The design of the joint formation is decisive for further work planning. On one hand the surface of the façade has to be waterproof against driving rain and the entire new envelope should constitute an air tight layer. But on the other hand – if there are damages or the necessity of access to the intermediate space the intermountability should be possible. Additionally tolerances between the single modules should allow an easy assembly and expansion and movements caused by temperature.

➔ Main issue is to raise awareness – every detailed planning decision indicates implications for further maintenance and repair.

		Advantages	Disadvantages	Implications on structural system and joint
<b>Fixed module system</b>		Simple and quick assembling  Good sealing and waterproofing (driving rain, air tightness)	No access to intermediate space between old/ new façade  Limited intermountability if modules are damaged	Standing or hanging construction system  Tongue and groove joints or rabbet
<b>Single fixed modules</b>		Intermountability of single damaged modules  Access to installations and intermediate space	More effort and carefulness during planning and assembling  Sealing and waterproofing needs more detailed planning and careful assembling	Open joint formation with cover profiles or rabbet with slide-in technique  Only hanging construction system possible

Table 26: Overview joining techniques of (semi-) prefabricated modules

## 8.2. Structural design

There are two different scenarios:

- The existing structure is able to bear the loads of the new façade system
- The existing structure is not able to bear the load of the new façade system

If the load bearing capacity is too little either a load distributing substructure is possible or the new façade has to be implemented as self-standing construction. Very often the foundation – invisible from outside – is forgotten. To avoid future settings an examination of the bearing capacity of the existing foundation shows which further loads can be carried. If capacities are too little either a reinforcement of the existing foundation helps or a new foundation is necessary.

Depending on whether a standing or suspended construction system is chosen, it is either possible to fix the modules directly upon the old façade or to mount a substructure. Depending on the module-size it is possible to implement a single-span beam construction or a continuous beam construction.

Furthermore the fastening subsurface influences the bearing system - it is either a massive structure, a skeleton or plate type construction.

	Suspended construction		Standing construction	
Substructure	<p>Load application „suspension“ within eaves, attic or roof</p> 	<p>Load distributing substructure upon existing subsurface</p> 	<p>Area-covering structure element (module acts as plate), additional fixing on the top necessary</p> 	<p>Area-covering structure element (module acts as plate), several fixing points all over the façade</p> 
Foundation	<p>Load transmission via existing construction → existing foundation is sufficient</p> 	<p>Load transmission via existing construction → existing foundation has to be reinforced</p> 	<p>New foundation</p> 	<p>Load application upon the plinth via existing foundation</p> 
Dimensioning	<p>Slimmer module sizes</p>	<p>Slimmer module sizes</p>	<p>Thicker module sizes necessary (Buckling stability)</p>	<p>Lower thickness of modules (shorter buckling length)</p>

Table 27: General overview on structural design of the new façade system [13]

Massive constructions as subsurface offer the possibility of either direct fixing or mounting a substructure. A substructure evens out uneven façades in preliminary stages. A faster proceeding of further module assembling is possible. Nevertheless mounting the substructure needs preparation on-site and therefore either scaffolding or mobile cranes are necessary.

Fixing at floor level has the advantage of potential better load bearing properties, because mostly intermediate floors are made as reinforced concrete slabs or there is an existing grid beam. Even if walls have low load bearing capacities (like porous concrete or gas concrete,..) skeleton- or plate-type construction systems offer limited possibilities of direct fixing – the raster has to be adapted to the possible subsurface fixing points. The direct fixing extends the assembling procedure but no preliminary work is necessary.

Module sizes spanning more than one level are difficult to implement (transport and lifting). A possible size could be a sanding module spanning the entire height of the façade, but with limited width (about 3 meters). Every system that uses more fixing points with smaller distances in-between reduces bearing loads and improves capacity to resist wind loads. Additionally the buckling length is reduced – the entire construction can be designed slimmer.

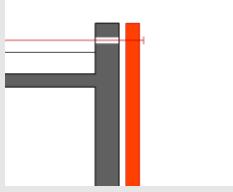
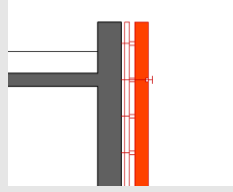
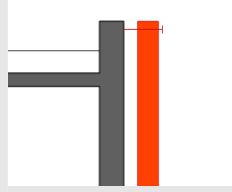
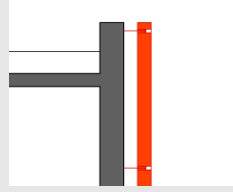
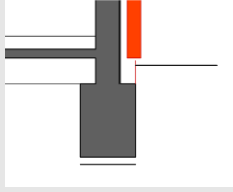
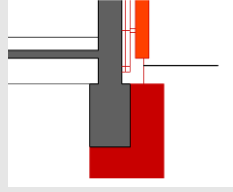
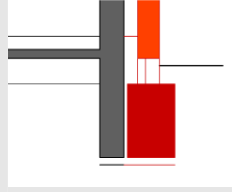
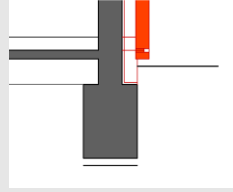

	<b>Single-span beam construction</b> Module system is mounted directly on subsurface or upon substructure	<b>Continuous beam construction</b> Continuous beam acts as substructure
<b>Suspended construction</b>	 Fixed support on top	 Fixed support on top
<b>Standing construction</b>	 Fixed support at the bottom	 Fixed support at the bottom
<b>Evaluation</b>	Modules have to be self-supporting. Additional substructure not mandatory. Without substructure every module has to be adjusted during assembling. Interchangeability of each module is possible.	Modules may be designed slimmer. Equalization of uneven subsurfaces by substructure. Assembling modules on substructures enables faster proceeding. Single modules are exchangeable.
<b>Tolerances</b>	Tolerances to allow movements emerging from temperature of each module.	Tolerances to allow movements emerging from temperature of each module.

Table 28: Overview on different bearing systems for module systems [13]. Legend:



The challenge within old buildings is the uncertainty of load bearing properties and load capacities as well as uneven subsurfaces or damages in the existing structure.

There is a broad product range of manufacturers offering fixing and mounting systems. They can be differed in dot-shaped and line supported fixings systems. Every dot-shaped fixing carries loads selectively and concentrated into subsurface – a disadvantage is when there are weak points within the old walls. Line supported fixing systems are more flexible due to inhomogeneous existing structures.

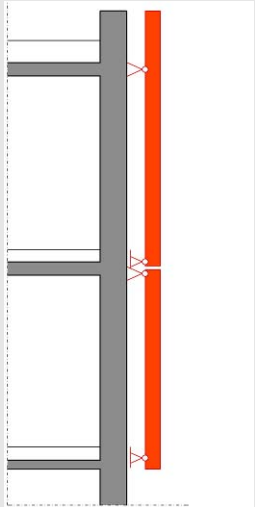
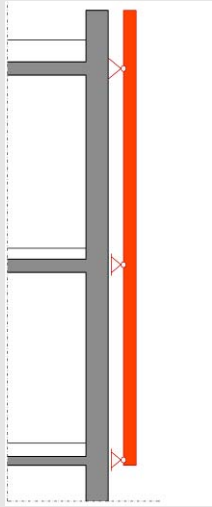
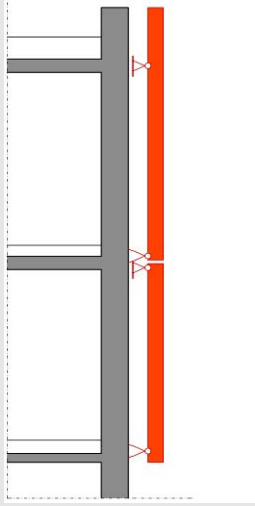
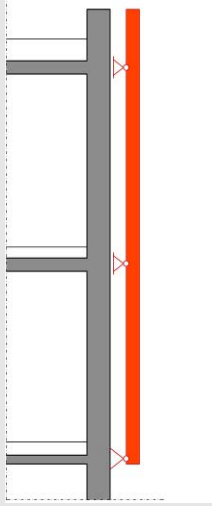
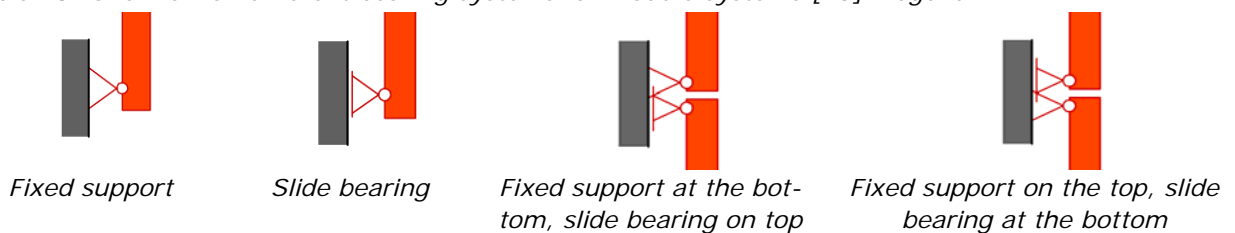

Figure 30: Steel angles as support brackets at the bottom. Example: Dieselweg Graz



Figure 31: Levelling laths made of a timber substructure. Example: Dieselweg, Graz

Individual support brackets are suitable support areas for standing construction systems at the bottom. But they can also be used for support of suspended or standing constructions at the top (Figure 30).

Furthermore every fixing system has to be able to absorb movements and stresses caused by temperature-related expansions. The acceptance of these movements can be guaranteed by the arrangement of elongated holes between substructure and module.

Wooden substructures (Figure 31): Referring to the application of timber framework or wood-based boards it subsequently makes sense to use the same material for the substructures. The advantage is an easy workability – the customization on-site is easy, it is light weight compared to steel and different profiles are congenial available. The disadvantage – compared to steel or aluminium substructures is the lower load bearing capacity, a less form-retentive property and the combustibility. Due to fire-prevention requirements it has to be proved in each case if a planned timber substructure is sufficient.

In order to find adequate anchors or dowels or further fixing possibilities for different applications a lot of product catalogues or guidelines are available. Exemplary the following are mentioned (but there are more of them offering good advice):

[www.fischer.de/desktopdefault.aspx/tabid-244/150\\_read-120/](http://www.fischer.de/desktopdefault.aspx/tabid-244/150_read-120/)  
[www.hilti.at/data/editorials/-11888/ratgeber\\_duebel\\_online-2005.pdf](http://www.hilti.at/data/editorials/-11888/ratgeber_duebel_online-2005.pdf). Download 09.11.2009  
[www.wuerth.de/de/medien/zul/duebel/uebersicht-duebel.pdf](http://www.wuerth.de/de/medien/zul/duebel/uebersicht-duebel.pdf)  
[www.werkzeugforum.de/fileadmin/pdfs/know\\_how\\_duebel.pdf](http://www.werkzeugforum.de/fileadmin/pdfs/know_how_duebel.pdf)

➔ Main issue is to raise awareness – early coordination with static engineer provides a target-oriented planning.

## 9. Service module kit

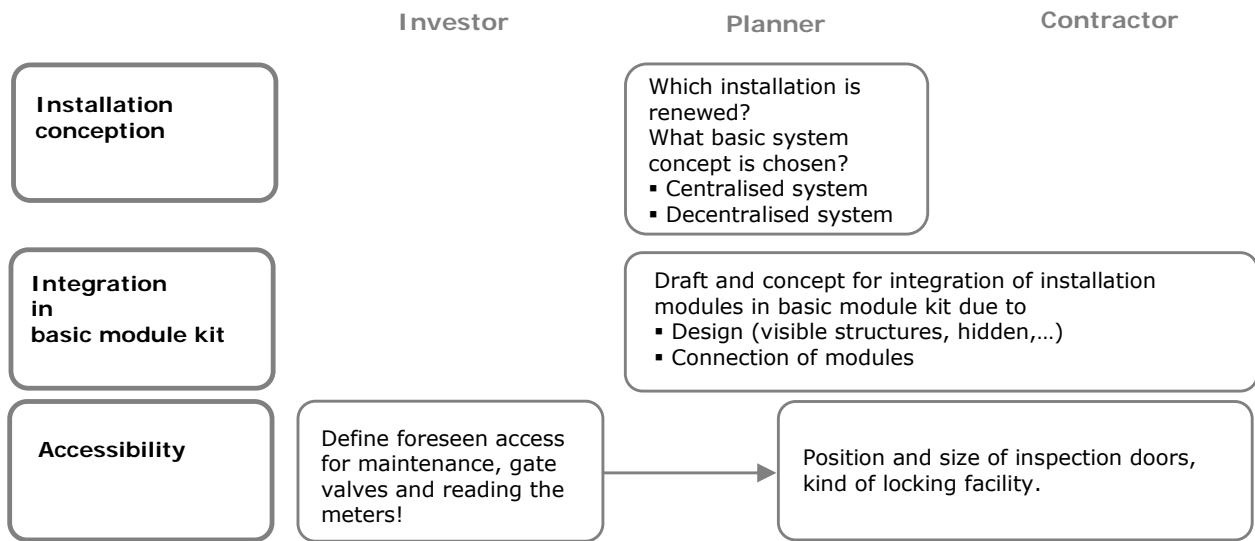

After a period of 20-25 years existing building services (HVAC<sup>27</sup> systems) can be stated as outdated. The renewal of DHW<sup>28</sup> - or heating-dissipation leads to measures within existing installation shafts or new ones have to be installed. But in any case it is necessary to carry out measures within the apartments.

Due to binding legal regulations about the protection of tenants or condominiums it is often very difficult to implement comprehensive renewal of piping if only one occupant does not agree on planned measures. But the chance to complete renovation of building structure and buildings services should not be forgotten. A comprehensive renovation (thermal envelope and building services) provides the possibility to optimize all systems and to complete renovation all at once.

The upgrading of piping or installation as a single measure at a later date is more expensive than carrying them out together with other works. And it will lead to further disturbance and discomfort for users.

### 9.1. Installation concept

As a result from the investigation of the building stock (see 2.1) the existing supply and position of installation shafts should be known. Following measures can be necessary:

- Renewal or adoption of energy generation for DHW and space heating
- Renewal or adoption of the distribution and/or dissipation system for DHW and space heating
- Renewal or adoption of heat storage for DHW and space heating
- Renewal or adoption of further piping or wiring (water, sewage, electric wiring, television, ...)

First of all it should come to the decision which installation has to be renewed. Existing installation should be checked:

- On functionality - it is not always necessary to demount fully functional installation.
- On their potential for optimisation –after renovation the entire system should be optimized from generation to distribution and dissipation.

<sup>27</sup> HVAC means „Heating, Cooling and Air Condition“

<sup>28</sup> DHW means „Domestic Hot Water“

The crucial point is the basic concept on energy generation of DHW and space heating. It is possible – for both – to install centralised or decentralised systems.

	Decentralised system	Centralised system
<b>Description</b>	Supply of DHW or space heating is done separately in each unit or apartment.	Supply of DHW or space heating is arranged for all together in a centralised station.
<b>Advantages</b>	Less piping, independent systems	Centralised system causes less effort on commissioning and maintenance works. Optimisation potential easier to achieve.
<b>Disadvantages</b>	A lot of units with potential of error rate, more effort for commissioning, maintenance. Optimisation more or less in scope of responsibility of each occupant.	A lot of piping, which has to be installed and causing losses.
<b>Implications</b>	More attention on support for single units (for service, control and in case of errors)	Control, service and repair are done by skilled personal.

Table 29: Overview on different concepts for DHW and space heating

➔ Main issue is to develop a sufficient and adequate installation concept.

## 9.2. Integration in basic module kit

Shaping a new thermal envelope provides the possibility to integrate prefabricated installation modules on the outside of the existing wall but inside the new thermal envelope. Prefabricated installation inside the buildings is currently state-of-the-art. Not only shafts, even entire installation blocks or comprehensive sanitary blocks are prefabricated, transported on-site and fixed on the planned positions – only some connecting work is necessary. This technology can be adopted for external use.



Figure 32: Installation module inside the building  
(Source: Ziv.Ing. Büro Boder)



Figure 33: Transfer station installed inside a building

But so far it has not been implemented during renovation – maybe the problem of arranging water-conducted pipes on the cold outside has not been solved yet. But the advantage of installation on the outside within renovation is that installation works inside the apartments are reduced, occupants are less disturbed and it is possible to renew piping during occupancy. If one tenant refuses works within his

flat it is possible to connect all other apartments with the new installation system because it is not necessary to lead pipes through this specific unit.

How to overcome the hazard of freeze on the outside? Table 30 shows two possibilities.

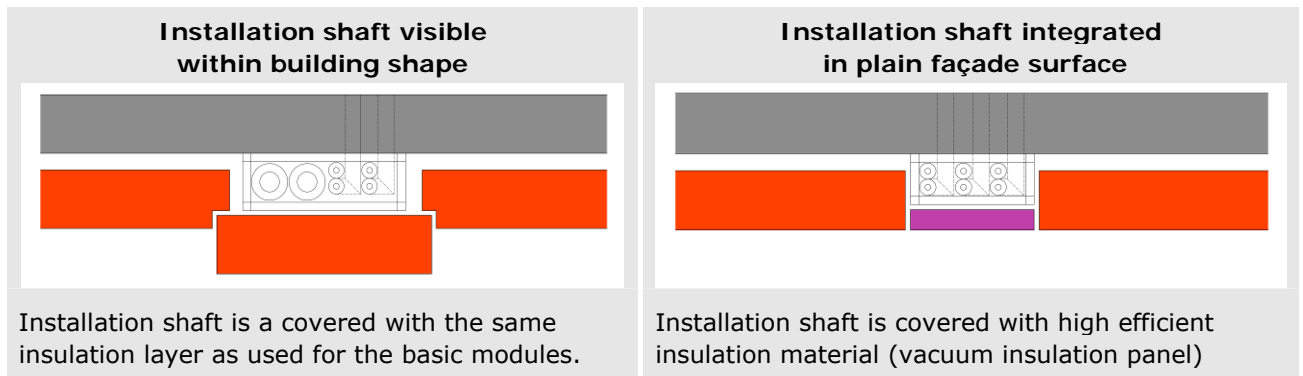

Table 30: Examples of integration of installation shafts in module system

➔ Main issue is to integrate the installation ducts technically correct into the design of the new façade.

### 9.3. Accessibility

In case of installation shafts within the building it is very difficult to get access in case of a burst pipe – mostly it remains undiscovered for a long time. Every upgrading is hard to implement and even metering is not always easy to solve. Installation shafts on the outside provide the possibility to arrange inspection doors – with access from a public space. It is no longer necessary to get access to single apartments – it is not necessary to bother tenants for upgrading, repair, maintenance or reading the meter.

But following aspects due to the position of the inspection doors have to be decided:

- Locking facility – who is allowed to access? This an important issue if there are stop- or turn cocks for main supply lines or apartment supply lines, gate valves or meters for reading related to each apartment.
- Position and size of inspection door – preferable it is reachable without ladder.

➔ Main issue is to raise awareness for further facility management necessities.

## 10. Active module kit

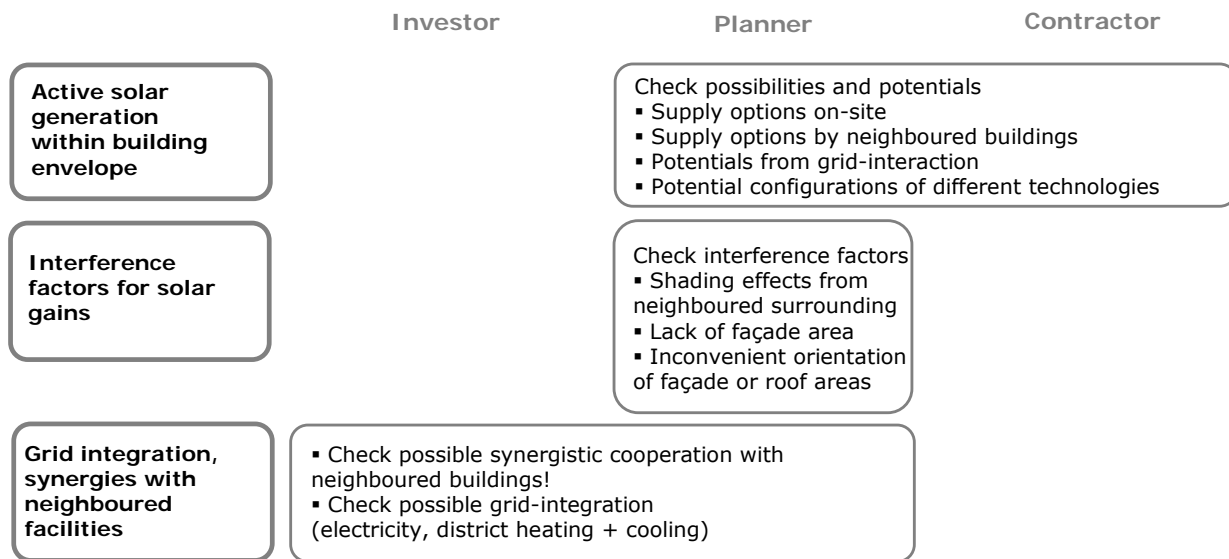

Future buildings will mutate from energy consumers to decentralised energy suppliers. Therefore it is necessary to produce energy on-site.

Different renewable energy sources are possible:

- Photovoltaics (PV)
- Solar thermal plants (ST)
- Wind mills or turbines
- Biomass – thermal heating system or CHP

Referring to the mentioned possibilities it is only a photovoltaic or solar thermal plant, which may be integrated in façade areas. Wind mills or turbines are hardly able to be system-integrated. Therefore such facilities are not treated in this context.

### 10.1. Active energy generation within building envelope

Until now the main objective of a façade was the protection against weather or outdoor conditions and the maintenance of indoor climate conditions as well as the visual appearance of a building. Active energy generation within the façade enlarges this task area.

Due to the complexity, architects and energy-engineers must co-operate in a very early planning stage. A lot of relevant preliminary decisions of the architect during the design phase have significant influence on the further operation of the active systems. Orientation, incline, position and size are given by the shape of the thermal envelope.

The irradiations at the façade or on the roof are composed by direct radiation from the sun, reflection from the surroundings and diffuse irradiation. The average global irradiation for Central Europe is between 900 – 1.200 kWh per square meter. Within some exceptional regions (for example in the mountains) this factor may raise up to 1.400 kWh per square meter [17]. To reach the maximum energy yield it is necessary to focus on the highest possible fraction of direct radiation and upright impinging rays of the sun. Generally the irradiation on façade areas (90° areas) is about 30% less than on 45° areas (pitched roofs). Every façade oriented south shows a very steady radiation profile and the total radiation over the year shows a maximum solar yield.

A deviation of collector area to south-west or south-east diminishes the annual yield of about 3% compared to straight south-orientation. Bigger variances up to straight east or straight west-orientation lead to further losses [18].

In many regions in middle Europe like Austria, Switzerland or the south of Germany it is common to have a lot of snow during a long time of the year. Snow effectuates that the share of reflected irradiation is increasing. This percentage is even the bigger the higher incline from the horizontal area. During winter season the irradiation on a vertically oriented area (90° - façade) is higher than on 45° pitched areas (roof) – in case of snow.

Basically solar thermal plants with vertically oriented collectors need more collector area, to gain the same solar coverage rate as plants with 45° incline. But due to more balanced radiation profile over the year – to meet permanent consistent user profiles for PV and solar combi systems it can be stated that the additionally necessary area is smaller – compared to pure DHW-solar thermal plants.

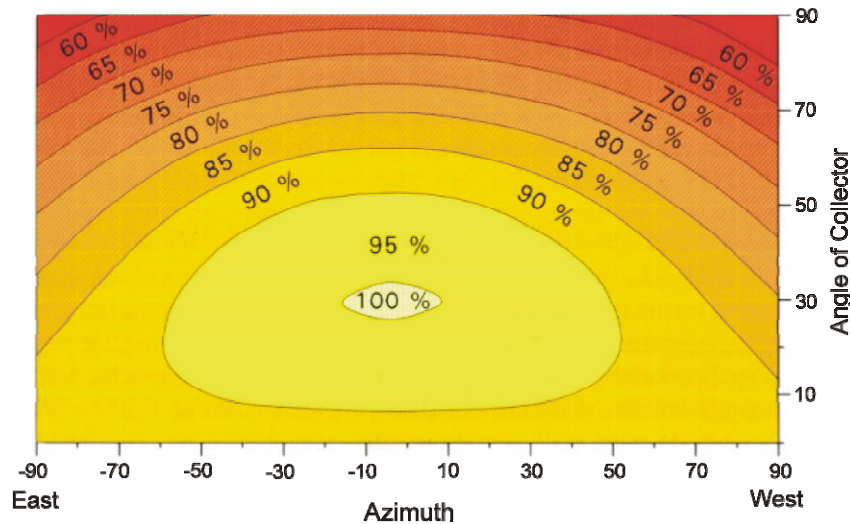

Figure 34: Reduction of efficiency of solar thermal systems for DHW generation due to the orientation and the incline of the collector.

#### Note!

Clarify what the suitable and available areas within the existing building shell are. Are extensions or additions of the existing building possible?

➔ Main issue is to optimise module integrated collector area.

## 10.2. Interference factors for solar gains

Shading of solar thermal collectors or photovoltaic modules causes reduced energy yields. Every shaded part of a solar thermal collector can not gain thermal energy but it acts as a cooler: if one part of the collector area is irradiated and therefore the heat transfer medium is heated, thermal energy is given off within the shaded part.

Shading may arise from:

- Projecting roofs or storeys
- Neighbouring buildings or facilities
- Trees or bushes

Photovoltaic modules are even more sensitive and already very small shaded parts will act as resistors and therefore cause vast losses [17]. Typical obstacles are:

- Chimneys
- Satellite dishes
- Projecting venetian blinds or flashings of attics
- Leaves
- Bird droppings

A possibility to avoid enormous losses due to partly shaded photovoltaic modules is to interconnect the single modules in an intelligent way. This means to separate modules referring to the process of shading over the day. Generally spoken it can be stated that optimized gains are only possible if the entire collector or module area is free of shade.

Especially in urban areas, which are mostly densely developed, it is a challenge to find enough area which is not shaded. Often it is easier to find unshaded area on roofs, but due to larger buildings or larger demands the roof area is mostly too small and within façade areas the interference from surrounding buildings and the above mentioned factors are more dominant and residential buildings want to have a view and openings south-oriented. Additionally existing buildings have a more or less unalterable position, orientation and envelope. The scope to make alterations is very small.

$h = d \times \tan \alpha$   
 $\alpha = 90^\circ - \beta$   
 d [m] ... Distance between object and facade  
 h [m] ... Height of object from bottom line of collector  
 $\alpha$  [°] ... Angle of height  
 $\beta$  [°] ... Angle of zenith of the sun  
 $\beta$  Graz (Austria), Dec. 21th =  $70^\circ$

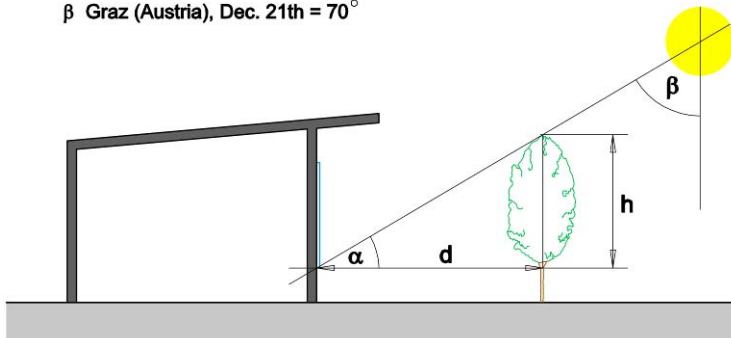

Figure 35: Shadow casted by a tree upon a south-oriented façade (Source: Colourface [18])

$h' = d' \times \tan \beta$

$d'$  [m] ... Upper line projecting roof - upper line collector  
 $h'$  [m] ... Projecting roof  
 $\beta$  [°] ... Angle of zenith of the sun  
 $\beta$  Graz (Austria), June 21th =  $24^\circ$

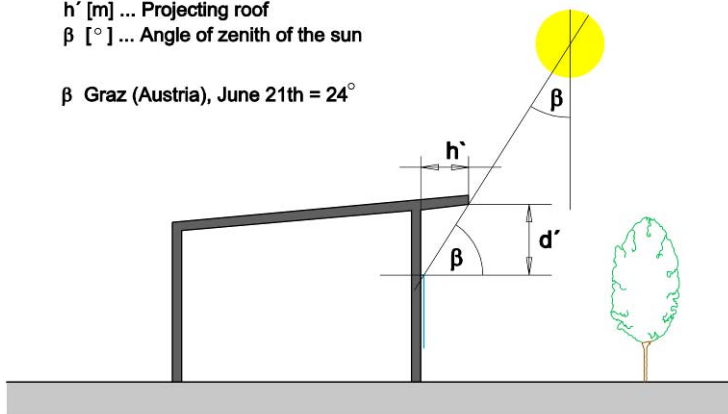

Figure 36: Shadow casted by a projecting roof upon a south-oriented façade (Source: Colourface [18])

Figure 35 shows necessary distances and possible heights of plants or objects positioned in front of the existing façade. It is essential that even at the lowest altitude of the sun in December the bottom of the collector or PV module is not shaded. Figure 36 depicts the possible overhang of projecting roofs considering the fact that even at time of the highest altitude of sun in June no shadow is falling upon the upper side of the collector or PV panel.

As mentioned above it might be difficult to find enough suitable area for active energy generation on the buildings envelope. But maybe it is possible to find facilities on-site (carport, roofing of bicycle park) or synergies with neighbours. Just in urban areas a lot buildings do not have the necessity of a view and may provide large areas for active energy generation (shopping malls, supermarkets, parking decks, cinemas, function rooms).



➡ Main issue is to optimise solar yield of building envelope.

### 10.3. Grid integration and synergies with neighbours

Any produced energy that is thermal energy or electricity needs customers or has to be stored for future usage. Following possibilities can be stated:

- Own consumption at the time of production
- Storage on-site (within the system- boundary of the building)
- Feeding into grids (heating grids, electricity grid)

Long-time storage of thermal energy is presently limited due to lack of suitable storage technologies and economically hardly feasible. It needs a large space (buffer storage tanks of multi-family houses need more than 5 m<sup>3</sup>). Further the possibilities for storing electricity in battery packs are not possible at an economic scale as well. Some innovative pilot projects are on the way, ideas of using batteries of electric vehicles are emerging – but until first successful implementation there is further need for research.

Until economic concepts are available it is necessary to integrate buildings into grids – the grids act as permanent customers – so that it is possible to uncouple energy generation and consumption.

While feeding into electric grids is a mature technology the integration of decentralised production into thermal (heating) grids is in its beginnings. The technology is available – but the complexity is even higher. Supply and return temperatures as well as the hydraulic concept have to be considered. More and more innovative projects have been installed in the last years, where decentralised solar thermal plants are integrated into heating grids or shared within smaller districts and combined with biomass cogeneration stations. Some examples like the solar supply of the district heating of the city of Graz (Styria) or several solar supplied residential areas can be found under:

[www.solid.at/index.php?option=com\\_content&task=view&id=89&Itemid=129&lang=en](http://www.solid.at/index.php?option=com_content&task=view&id=89&Itemid=129&lang=en)

A possible future solution is to consider user profiles at a very early stage. Finding synergies within the neighboured facilities – especially with demand which is different from the own consumption may lead to intelligent micro-grids. For example the user profiles from residential buildings are different from office and administrative buildings or retirement or nursing homes (DHW, heating, cooling).

➡ Main issue is to enlarge the scope to surrounding facilities and prepare energy-efficient settlements.

## References

Publications within the IEA ECBCS Annex 50<sup>29</sup>:

- [I] Mark Zimmermann: ECBCS Project Summary report "Annex 50 Prefabricated Systems for Low Energy Renovation of Residential Buildings, October 2011
- [II] Peter Schwehr, Robert Fischer, Sonja Geier: Retrofit Strategies Design Guide, ISBN 978-3-905594-59-1, March 2011
- [III] René L. Kobler, Armin Binz, Gregor Steinke, Karl Höfler, Sonja Geier, Johann Aschauer, Stéphane Cousin, Paul Delouche, François Radelet, Bertrand Ruot, Laurent Reynier, Pierre Gobin, Thierry Duforestel, Gérard Senior, Xavier Boulanger, Pedro Silva, Manuela Almeida: Retrofit Module Design Guide, ISBN 978-3-905594-60-7, March 2011
- [IV] Reto Miloni, Nadja Grischott, Mark Zimmermann, Chiel Boonstra, Sonja Geier, Karl Höfler, David Venus: Building Renovation Case Studies, ISBN 978-3-905594-61-4, March 2011
- [V] Mark Zimmermann, Hans Bertschinger, Kurt Christen, Walter Ott, Yvonne Kaufmann, Stefan Carl: Retrofit Advisor, Beta-version, March 2011
- [VI] Peter Schwehr, Robert Fischer: Building Typology and Morphology of Swiss Multi-Family Homes 1919 – 1990, January 2010
- [VII] Bertrand Ruot: French housing stock built between 1949 and 1974, October 2010
- [VIII] Bertrand Ruot: Elements of morphology of collective housing buildings constructed in France between 1949 and 1974, October 2010
- [IX] Gerhard Zweifel: Retrofit Simulation Report, March 2011

Further sources Part B:

- [1] Frey K., Haas J.: „Handbuch für Energieberater.“ Forschungsgesellschaft Joanneum Graz – Institut für Energieforschung, Graz 1994
- [2] Energieinstitut Vorarlberg: „Technische Erläuterungen. Kriterien zum klima:aktiv passivhaus für Wohngebäudesanierungen. Version 1.1“; 16. Februar 2009, Pkt. A 2.1. pages 12-13
- [3] Geier Sonja: „ÖKOSAN-Ökoeffiziente Sanierungsinitiative Oststeiermark. Projektphase II“; März 2009, page 99
- [4] Feist Werner, et al: „Passivhaus Projektierungspaket 2007“, Darmstadt 2007
- [5] EN 1998 - Eurocode 8: „Design of structures for earthquake resistance – Part 1: General rules, seismic actions and rules for buildings“, [www.eurocode-resources.com/eurocode-8-en-a14.html](http://www.eurocode-resources.com/eurocode-8-en-a14.html)
- [6] Burger C.: „Schlupflöcher im Dachbodenausbau.“ Format Immo-Special 2/09, pages 8-9
- [7] Österreichischer Bundesfeuerwehrverband, et al.: „TRVB A 107 – Brandschutzkonzepte“, 2004, page 2
- [8] Teibinger Martin: „Brandverhalten von Holz- und Holzwerkstoffen“, Holzforschung Austria download am 26.01.2010, [www.holzforchung.at/fileadmin/Content-Pool/PDFs/Brandverhalten.pdf](http://www.holzforchung.at/fileadmin/Content-Pool/PDFs/Brandverhalten.pdf)
- [9] IBO – Austrian Institute for Healthy and Ecological Building (Ed.): "Details for Passive Houses. A catalogue of ecologically rated constructions", Wien 2009
- [10] Mötzl Hiedgund: „Ökologische Produktwahl“, IBO-Magazin 4/09, pages 2-4

<sup>29</sup> Further information at home pages: [www.empa-ren.ch/A50.htm](http://www.empa-ren.ch/A50.htm), [www.ecbcs.org/annexes/annex50.htm](http://www.ecbcs.org/annexes/annex50.htm)

- [11] Lipp, Bernhard: „Der OI3-Index“, IBO-Magazin 2/06, pages 3-7
- [12] Mötzl Hildegund, Pladerer C., et al.: “Assessment of Buildings and Constructions (ABC) Disposal”, Berichte aus Energie- und Umweltforschung 12/2009. Wien, [www.ibo.at/de/forschung/index.htm](http://www.ibo.at/de/forschung/index.htm)
- [13] „Tragwerksysteme“, „Montagetechnik“, „Verankerungssysteme“, [www.baunetzwissen.de/](http://www.baunetzwissen.de/); download 12.01.2010
- [14] Hilti Austria Ges.m.b.H: „Ratgeber: Dübeltechnik Basiswissen“, Wien 2005  
[www.hilti.at/data/editorials/-11888/ratgeber\\_duebel\\_online-2005.pdf](http://www.hilti.at/data/editorials/-11888/ratgeber_duebel_online-2005.pdf). Download 09.11.2009
- [15] „Grundlagen der Dübeltechnik“.  
[http://www.fischer.de/desktopdefault.aspx/tabid-244/150\\_read-120/](http://www.fischer.de/desktopdefault.aspx/tabid-244/150_read-120/); download 09.11.2009
- [16] “Die Welt der Dübel”;  
[www.werkzeugforum.de/fileadmin/pdfs/know\\_how\\_duebel.pdf](http://www.werkzeugforum.de/fileadmin/pdfs/know_how_duebel.pdf); Download 09.11.2009
- [17] Klima- und Energiefonds: „Photovoltaik-Fibel 2011“, Wien 2011,  
[www.klimafonds.gv.at](http://www.klimafonds.gv.at)
- [18] Müller Thomas, Bergmann Irene, Hausner Robert, Höfler Karl, Nussmüller Werner: „Colourface – Planungsrichtlinien für farbige Fassadenkollektoren“, Gleisdorf 2003, Pages 9-10, 13



Published by:



Research Partners:

AEE - Institute for Sustainable Technologies (AEE-INTEC), Austria

Enviros s.r.o., Czech Republic

Brno University of Technology, Institute of Building Services, Czech Republic

Centre scientifique et technique du bâtiment CSTB, France

Saint-Gobain Isover, E3 Performances / ArcelorMittal, France

EDF, AETIC, ALDES, Vinci Constructions, France

Energy Research Centre of the Netherlands ECN, Netherlands

Porto University, Faculty of Engineering, Portugal

University of Minho, Civil Engineering Department, Construction and Technology Group, Portugal

CNA Arkitektkontor AB, Sweden

Energy and Building Design, Lund Institute of Technology, Sweden

Lucerne University of Applied Sciences and Arts, Technology and Architecture, Switzerland

University of Applied Sciences Northwestern Switzerland, School of Architecture,

Civil Engineering and Geomatics, Switzerland

Swiss Federal Laboratories for Materials Science and Technology Empa,

Building Science and Technology Laboratory, Switzerland